

Becusa, fabricante de todo tipo de bisagras para la industria del mueble desde 1970, presentamos ahora este nuevo catálogo que apuesta por una importante ampliación de nuestra gama de productos.

Entendida la calidad como un aspecto fundamental y base del prestigio que nos avala, un nuevo desarrollo logístico y un amplio stock de todas nuestras referencias garantiza la rapidez en las entregas para cubrir las necesidades puntuales de nuestros clientes en el mínimo plazo posible.

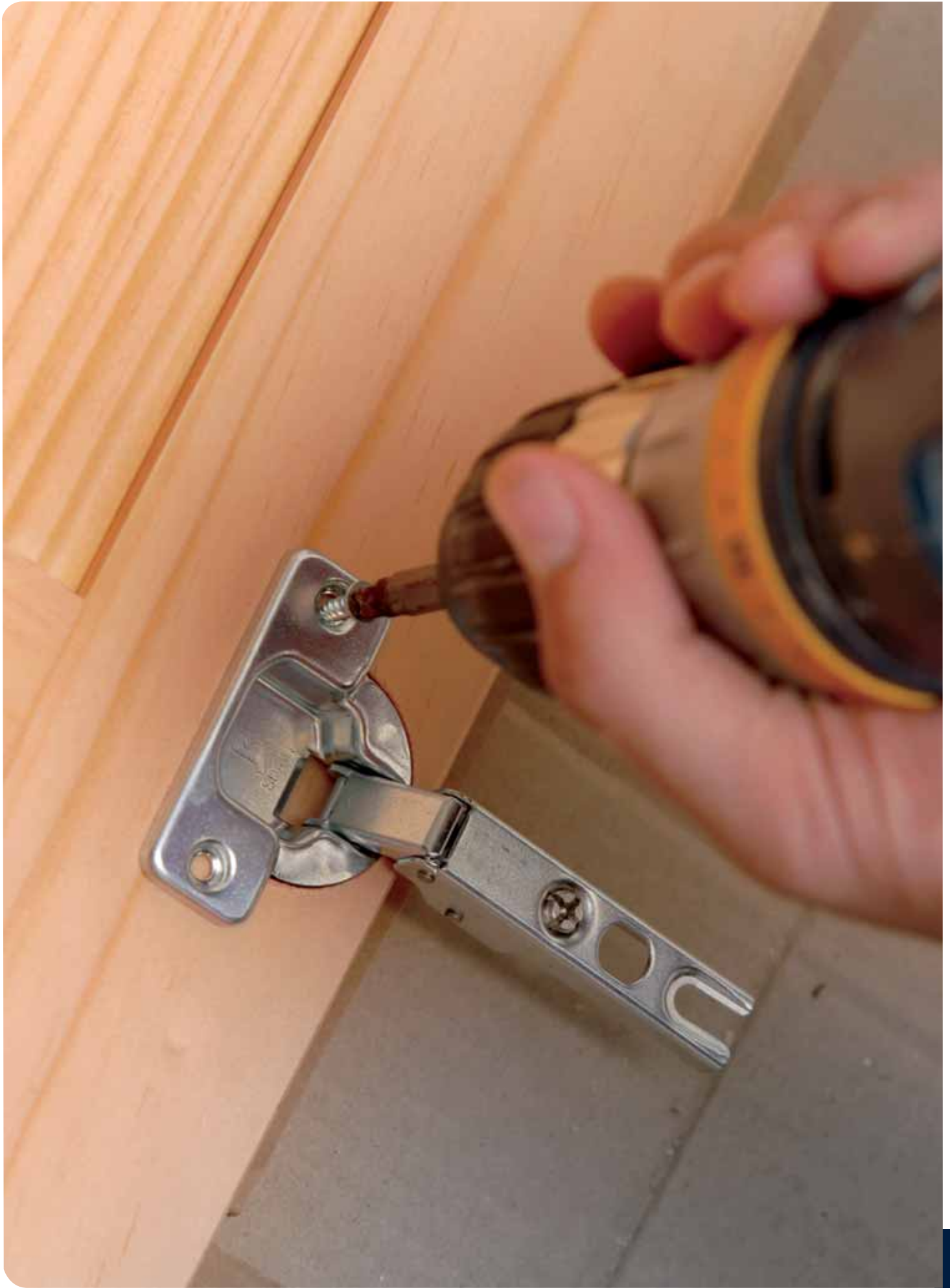

	1	<i>Bisagras de cazoleta</i>	3
	2	<i>Bisagras y Pernios</i>	17
	3	<i>Pasadores</i>	31
	4	<i>Picaportes</i>	37
	5	<i>Manillas</i>	41
	6	<i>Pomos y Tiradores</i>	49
	7	<i>Manillones y Bisagras de cristal</i>	55
	8	<i>Varios</i>	63



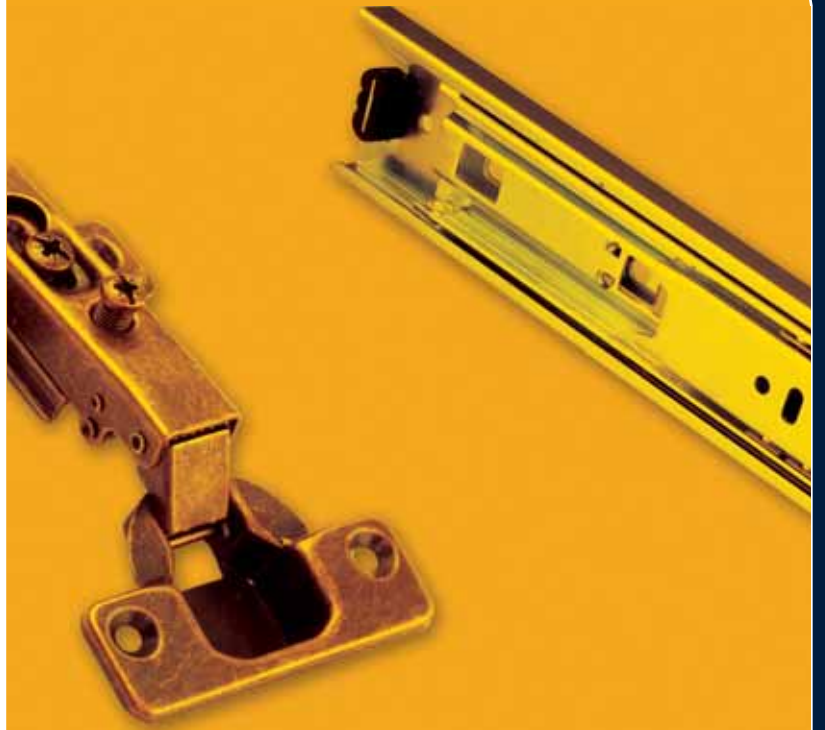

Bisagras de cazoleta y guías

Bisagras de Cazoleta 35 mm 110°	4-5
Bisagra Hidráulica y de tres regulaciones	6
Bisagras Euro Clip 35 mm.	7
Bisagras de Cazoleta 105° 35 mm.	8-9
Bisagras 26 mm 95°	10
Bisagras de Cierre Automático 95°	11
Bisagras de Cierre Automático	11
Bisagras de Cazoleta 26 mm.	12
Bisagras de Brazo Corto	12
Bisagras de Perfil de Aluminio 110°	13
Bisagras Americanas	14
Guías para cajones	14
Colgadores de armario y cama	15

bisagras de cazoleta

Bisagras de Cazoleta 35 mm 110°

REF. 737-L



■ **Ángulo de apertura**
110°

Brazo
Niquelado

Cazoletas
Metálica Niquelada

Recta - 0

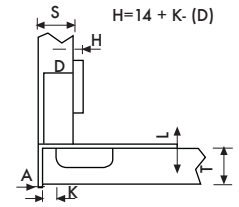

H	D
0	20
2	18
4	16

REF. 737-A

■ **Ángulo de apertura**
110°

Brazo
Niquelado

Cazoletas
Metálica Niquelada

Acodada - 8

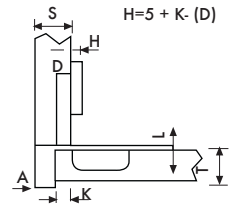

H	D
0	10
2	8
4	6

REF. 737-SA



■ **Ángulo de apertura**
110°

Brazo
Niquelado

Cazoletas
Metálica Niquelada

Super acodada - 15

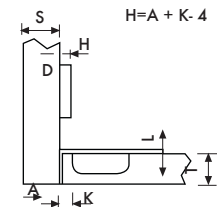

H	D
2	-

▼ **Fijación a la base**

Con taco de presión para agujero 10 mm.



Con tornillo.



Con tornillo euro 6,30 premontado largo 10, 14, 16 agujero de 5 mm.

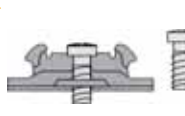

Con taco expansivo y tornillo pre-montado para agujero 5 mm.

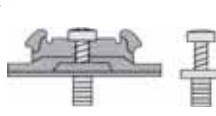

REF. PS-23



● Acabado Antique Brass



■ **Referencias disponibles**

Ref. 737-LBR Recta

Ref. 737-ABR Acodada

Ref. 737-SABR Superacodada

Bisagras de Cazoleta 35 mm 110°

REF. 737-LCL



Ángulo de apertura
110°

Brazo
Niquelado

Cazoletas
Metálica Niquelada

Recta - 0

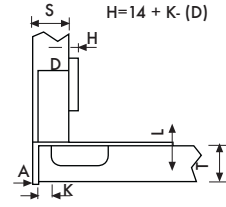

H	D
0	20
2	18
4	16

REF. 737-ACL

Ángulo de apertura
110°

Brazo
Niquelado

Cazoletas
Metálica Niquelada

Acodada - 8

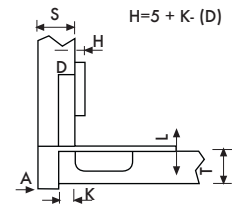

H	D
0	10
2	8
4	6

REF. 737-SACL



Ángulo de apertura
110°

Brazo
Niquelado

Cazoletas
Metálica Niquelada

Super acodada - 15

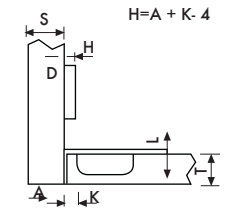

H	D
2	-

Fijación a la base

Con taco de presión para agujero 10 mm.



Con tornillo.



Con tornillo euro 6,30 premontado largo 10, 14, 16 agujero de 5 mm.

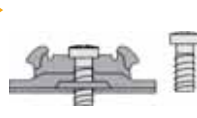

Con taco expansivo ytronilo premontado para agujero 5 mm.

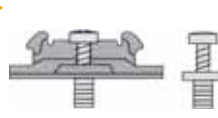

REF. PS-25

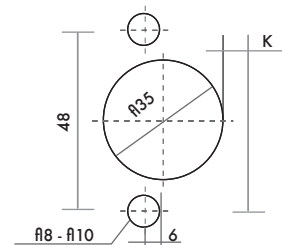
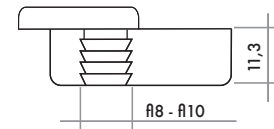

Bisagra Hidráulica y de tres regulaciones

REFS. PS-25E

REF. 737-LCL3



Recta - 0

Ref. 737-LCL3

Acodada - 9

Ref. 737-ACL3

Super acodada - 17

Ref. 737-SACL3



• Soporte excéntrico

• Bisagra de tres regulaciones

REF. 610-LCL



Recta - 0

Ref. 610-LCL

Acodada - 9

Ref. 610-ACL

Super acodada - 17

Ref. 610-SACL



• Bisagra de pistón



Bisagras Euro Clip 35 mm.

REF. 680-LCL



■ **Ángulo de apertura**
165°
Brazo
Niquelado
Cazoleta
Zamak

REF. 635-LCL

■ **Ángulo de apertura**
135°

Brazo
Niquelado

Cazoleta
Niquelado



REF. 690-LCL



■ **Ángulo de apertura**
90°

Brazo
Niquelado

Cazoleta
Niquelado

REF. 695-LCL

■ **Ángulo de apertura**
95°

Brazo
Niquelado

Cazoleta
Niquelado



bisagras de cazoleta

Bisagras de Cazoleta 105° 35 mm.

REF. 51-MC



- **Acabado Niquelado**
Ref. 51-MC
- **Acabado Cuero / Antique Brass**
Ref. 51-MCBBR
- **Recta - 0**

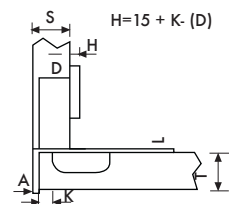

H	D
0	20
2	18
4	16

REF. 52-MC

- **Acabado Niquelado**
Ref.: 52-MC
- **Acabado Cuero / Antique Brass**
Ref.: 52-MCBBR
- **Acodada - 9**

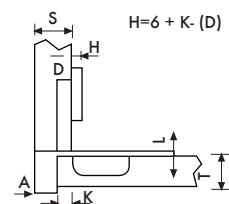

H	D
0	10
2	8
4	6

REF. 53-MC



- **Acabado Niquelado**
Ref. 53-MC
- **Acabado Cuero / Antique Brass**
Ref. 53-MCBBR
- **Super acodada - 17**

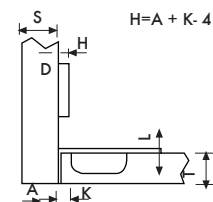

H	D
2	-

REF. PS-22



- Acabado Antique Brass



- **Referencias disponibles**
Ref. 51-MCBBR
Ref. 52-MCBBR
Ref. 53-MCBBR

Bisagras de Cazoleta 105° 35 mm.

REFS. 51, 251 y 253



Cazoleta

- Ref. 51: Zamak níquelado
- Ref. 251: Plástico blanco
- Ref. 253: Plástico Marrón

Recta - 0

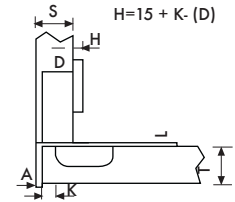

H	D
0	20
2	18
4	16

REFS. 52, 261 y 263

Cazoleta

- Ref. 52: Zamak níquelado
- Ref. 261: Plástico blanco
- Ref. 263: Plástico Marrón

Acodada - 10

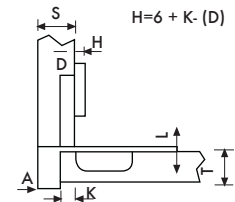

H	D
0	10
2	8
4	6

REFS. 53, 271 y 273



Cazoleta

- Ref. 53: Zamak níquelado
- Ref. 271: Plástico blanco
- Ref. 273: Plástico Marrón

Super acodada - 17

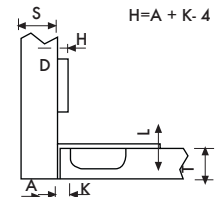

H	D
2	-

REF. PS-22



REF. PS-12



Bisagras 26 mm 95°

REF. 41-M



- **Brazo**
Niquelado
- **Cazoleta**
Niquelado
- **Recta - 0**

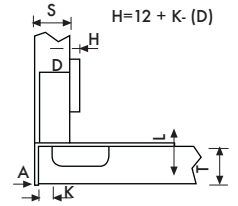

H	D
0	18
2	16
4	14

REF. 42-M

- **Brazo**
Niquelado
- **Cazoleta**
Niquelado
- **Acodada - 9**

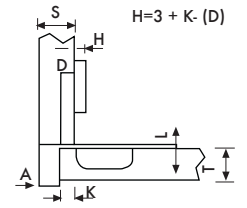

H	D
0	8
2	6
4	4

REF. 43-M



- **Brazo**
Niquelado
- **Cazoleta**
Niquelado
- **Super acodada - 17**

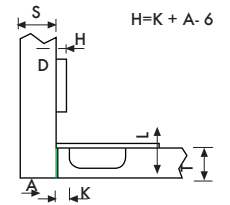

H	D
0	-

▼ Fijación a la base

Con taco de presión para agujero 10 mm.



Con tornillo.



Con tornillo euro 6,30 premontado largo 10, 14, 16 agujero de 5 mm.

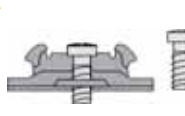

Con taco expansivo ytronilo pre-montado para agujero 5 mm.

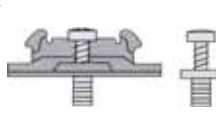

REF. PS-27

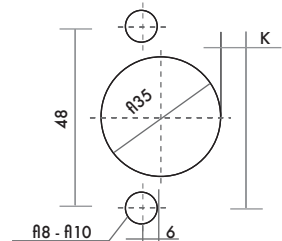
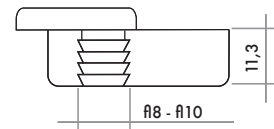

Bisagras de Cierre Automático 95°

REF. PS-1

REF. 206-M



Brazo
Zincado

Cazoleta
Zincada

Bisagras de Cierre Automático

REF. PS-7

REF. 221



Brazo
Niquelado

Cazoleta
Niquelada

REF. PS-20

REFS. 61-M y 61-Z



Brazo
Niquelado

Cazoleta Metálica
Ref. 61-M

Cazoleta Zamak
Ref. 61-Z

Bisagras de Cazoleta 26 mm.

REF. 41, 20041 y 20042



Cazoleta

Ref. 41: Zamak níquelado
 Ref. 20041: Plástico blanco
 Ref. 20042: Plástico Marrón

Brazo

Níquelado

Recta - 0

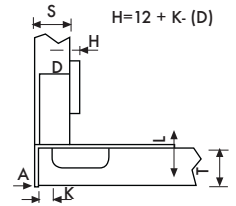

H	D
0	20
2	18
4	16

REF. 42, 20043 y 20044

Cazoleta

Ref. 42: Zamak níquelado
 Ref. 20043: Plástico blanco
 Ref. 20044: Plástico Marrón

Brazo

Níquelado

Acodada - 9

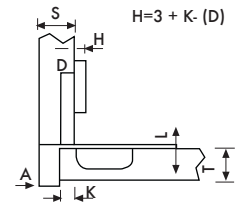

H	D
0	10
2	8
4	6

REF. 43, 20045 y 20046



Cazoleta

Ref. 43: Zamak níquelado
 Ref. 20045: Plástico blanco
 Ref. 20046: Plástico Marrón

Brazo

Níquelado

Super acodada - 17

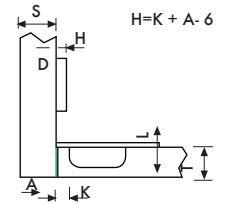

H	D
2	-

REF. PS-13



Bisagras de Brazo Corto

REF. 600

Soporte H0
 Níquelada

Soporte HZ
 Zamak

Soporte H2
 Altura



Bisagras de Perfil de Aluminio 110°

REF. 601-L



- **Ángulo de apertura**
110°
- Brazo**
Niquelado
- Recta - 0**

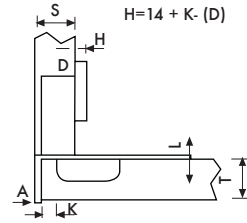

REF. 601-A

- **Ángulo de apertura**
110°
- Brazo**
Niquelado
- Acodada - 9**

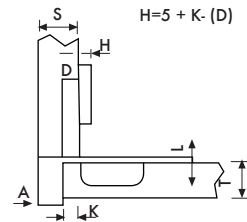

REF. 601-SA



- **Ángulo de apertura**
110°
- Brazo**
Niquelado
- Super acodada - 17**

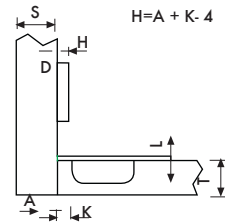

▼ Fijación a la base

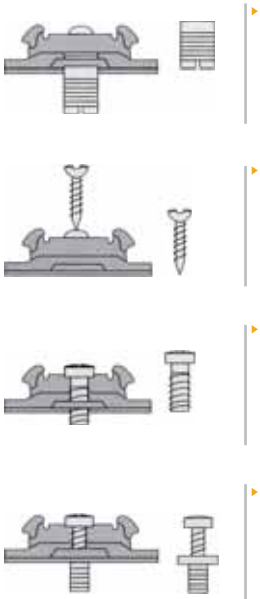

REF. PS-23

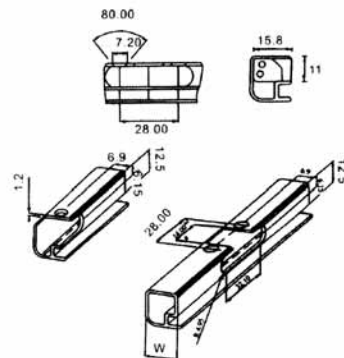

Bisagras Americanas

REF. BAS

Acabados

- BAS-L: Latonado
- BAS-AB: Antique Brass
- BAS-AC: Antique Copper
- BAS-NS: Nikel Satinado
- BAS-CR: Cromo brillo



• Sin muelle

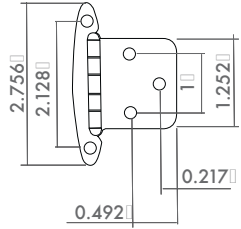

REF. BAV



• Con muelle

Acabados

- BAV-L: Latonado
- BAV-AB: Antique Brass
- BAV-AC: Antique Copper
- BAV-NS: Nikel Satinado
- BAV-CR: Cromo brillo

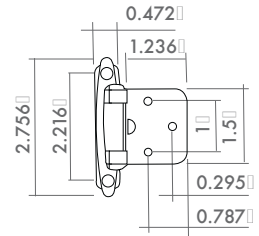

Guías para cajones

REF. G



Acabados

- B: Blanco Epoxi
- M: Marrón Epoxi

Medidas

- 250 mm.
- 300 mm.
- 350 mm.
- 400 mm.
- 450 mm.
- 500 mm.
- 550 mm.
- 600 mm.

REF. DB450

Acabados

- Zincado

Medidas

- 300
- 350
- 400
- 450
- 500
- 550
- 600

• Guías con rodamientos de 45 mm.



Colgadores de armario y cama

REF. 736-I y 736-D



- Colgador cartabón izquierda y derecha

REF. 730



- Colgador invisible e irreversible

REF. 7250



- Bastoncillo

REF. 7251



- Placa

REF. 733



- Placa doble

REF. 1



- Compás

REF. L



REF. U



- Soportes para cabeceros de cama





Bisagras y pernios

<i>Bisagras Fijas y Pernios de Acero Inox. 18/8 AISI 304</i>	18
<i>Pernios de Acero Inox. 18/8 AISI 304</i>	18-19
<i>Pernios de Seguridad de Acero Inox. 18/8 AISI 304</i>	20
<i>Bisagras de Seguridad de Acero Inoxidable 18/8 AISI 304 con rodamientos</i>	20
<i>Bisagras de Seguridad de Acero Inox. 18/8 AISI 304</i>	21
<i>Pernios Ignífugos de Acero Inox. 18/8 AISI 304</i>	21
<i>Bisagras de Vaivén de Acero Inox. 18/8 AISI 304</i>	21-22
<i>Bisagras Cuadradas de Acero Inox. 18/8 AISI 304</i>	22
<i>B. Cuadrada Inox. 18/8 de Seguridad con Rodamientos</i>	23
<i>Bisagra de Resorte de Inox. 18/8 AISI 304</i>	23
<i>Bisagra Cangrejo</i>	23
<i>Bisagras Pequeñas de Acero Inox. 18/8 AISI 304</i>	23
<i>Bisagra de Piano de Acero Inox. 18/8 AISI 304</i>	23
<i>Bisagras y Pernios de Latón</i>	24
<i>Bisagras de Seguridad 150x80x3</i>	25
<i>Pernios de 9,5 mm.</i>	26
<i>Bisagras de Vaivén de Aluminio</i>	27
<i>Bisagras Cuadradas de Hierro</i>	27
<i>Bisagra de Seguridad de 5 nudos</i>	28
<i>Bisagra de Seguridad de 5 nudos con rodamiento</i>	29
<i>Bisagra de Piso con Resorte</i>	30

Bisagras Fijas y Pernios de Acero Inoxidable 18/8 AISI 304

REF. 203

• Bisagra



REF. 207

• Pernio



Medidas

- 50x40 mm.
- 60x40 mm.
- 70x50 mm.
- 70x60 mm.
- 80x60 mm.
- 100x70 mm.

Acabados

- Satinado
- Inoxidable

Pernios de Acero Inoxidable 18/8 AISI 304

REF. 405



REF. 405-C



Medidas

- Ref. 405: 95x55x2 mm.
- Ref. 405C: 100x57x2 mm.

• Remate chato o plano

Pernios de Acero Inoxidable 18/8 AISI 304

REFS. 412 y 424

- Canto Cuadrado



Medidas

Ref. 412: 120x86x3
Ref. 424: 90x65x2,5

REFS. 413 y 423

- Canto Redondo



Medidas

Ref. 413: 120x86x3
Ref. 423: 90x65x2,5

REFS. 301-A, 302-A, 303-A y 424-A

- Media separación



Medidas

Refs. 301-A y 301-AR: 76x51,5x2
Refs. 302-A y 302-AR: 76x58x2,5
Refs. 303-A y 303-AR: 89x56,2x2
Refs. 424-A y 424-AR: 90x65x2,5

REFS. 301-AR, 302-AR, 303-AR y 424-AR



REF. 426, 428 y 430

- Separación completa



Medidas

Ref. 426: 100x86x3
Ref. 428: 90x65x2,5
Ref. 430: 120x86x3

REF. 425, 427 y 429



Medidas

Ref. 425: 100x86x3
Ref. 427: 90x65x2,5
Ref. 429: 120x86x3

Pernios de Seguridad de Acero Inoxidable 18/8 AISI 304

REF. 1278



■ **Medidas**
127x78x3
Acabados
Inoxidable

REF. 1280

■ **Canto cuadrado**
Ref.: 1280IOX
Canto redondo
Ref.: 1280IOXR
Medidas
120x80x3
Acabados
Inoxidable



Bisagras de Seguridad de Acero Inoxidable 18/8 AISI 304 con rodamientos

REF. 905-IOXR

● Con remate



REF. 905-IOXRC

● Sin remate



■ **Medidas**
150X80X3
Terminaciones
Canto cuadrado
Canto redondo r-16
Canto redondo r-10, r-12

Bisagras de Seguridad de Acero Inoxidable 18/8 AISI 304

REF. 905IOXC

- Canto Cuadrado



- Canto redondo (16,12,10)



Medidas
150x80x3

Pueden ser suministradas con remate largo Ref 905IOX

Pernios Ignífugos de Acero Inoxidable 18/8 AISI 304

REF. 480 y 481



Medidas
140x80x3

Con muelle
Ref. 480

Sin muelle
Ref. 481

Bisagras de Vaivén de Acero Inoxidable 18/8 AISI 304

REF. 909

- Con tirafondos Inox.



Acabados
Inoxidable

Medidas
3"
4"

Bisagras de Vaivén de Acero Inoxidable 18/8 AISI 304

REF. 907

REF. 908



- **Acabados**
Acero Inoxidable satinado
- **Medidas**
Ref. 908: 180x133x4
Ref. 907: 180x80x4

Bisagras Cuadradas de Acero Inoxidable 18/8 AISI 304

REF. 313

REF. 313-R



- **Acabados**
Inoxidable Antique Brass
Acero Inoxidable 18/8
- **Medidas**
2x2 mm.
2,5x2,5 mm.
3x3 mm.
3,5x3,5 mm.
3,5x3 mm.
4x3 mm.
4x4 mm.
5x3 mm.

• Con tirafondos Inox

• Con tirafondos Inox

• Con rodamiento

B. Cuadrada Inox. 18/8 de Seguridad con Rodamientos

REF. 313-S



Acabados
Inoxidable 18/8
Inox. Antique Brass

Medidas
3.5x3.5x2.5 mm.
4x4x3 mm.

- Con tirafondos Inox.

Bisagra de Resorte Inox. 18/8 AISI 304

REF. 482



Acabados
Inoxidable
Medidas
100x100x3 mm.

- Con tirafondos Inox.

Bisagra Cangrejo

REF. BC



Medidas
45x13 mm.
60x13 mm.
70x16 mm.
95x19 mm.
118x28 mm.
140x34 mm.

- Con tirafondos Inox.

Bisagras Pequeñas de Inoxidable 18/8

REF. 202



Medidas
Ref. 20275CC: 70x50 mm.
Ref. 20264CC: 60x40 mm.
Ref. 20254CC: 50x40 mm..

- Con tirafondos Inox.

Bisagra de Piano de Acero Inoxidable 18/8 AISI 304

REF. PIANOIOX



Medidas
32x0,7x1000 mm.
Acabados
Inoxidable

- Con tirafondos Inox.

Bisagras y Pernios de Latón

REF. 103

107107

• Bisagra



• Pernio



■ **Acabados**
Latón mate

■ **Medidas**
50x40
60x40
70x50
70x60
80x60
90x60
100x70

• Con canto redondo y cuadrado

REF. 400

REF. 401

• Sin remate



• Con remate



■ **Acabados**
Latón satinado
N Níquel satinado
CM Cromo mate
CB Cromo brillo
CO Cuero

■ **Medidas**
120x60x2,6
100x57x2,4

• Ahora también en aluminio



REF. 1280

REF. 905LR



■ **Terminaciones**
Canto cuadrado
Canto redondo



■ **Medidas**
120x80x4

■ **Medidas**
150x80x3

Bisagras de Seguridad 150x80x3

REF. 905C

- Sin remate / Remate corto



■ **Medidas**
150x80x3

REF. 905CR y 905E

■ **Medidas**
150x80x3
Radio
Ref. 905CR: 16
Ref. 905E: 12/10



REF. 905

■ **Acabados**
Latonado barniz
LD Lacado dorado
CM Cromado mate
N Niquelado
NM Niquelado mate
V Cuero envejecido
PN Negro Epoxi

REF. 905R



■ **Medidas**
150x80x3



- Con rodamiento

Pernios de 9,5 mm.

REF. 403



Acabados

- Latonado
- N Niquelado
- PN Negro
- PU Pulido
- LD Lacado dorado
- CM Cromado mate
- NM Niquel mate
- NI Niquelado satinado Inox
- V Envejecido

Medidas

95 mm.



REF. 403-C



Acabados

- Latonado
- PN Negro
- LD Lacado dorado
- V Envejecido

Medidas

95 mm.

• Sin remate o remate chato

REF. 404



Bisagras de Vaivén de Aluminio

REF. 907

REF. 908



■ **Acabados**

- B Blanco
- O Oro
- P Plata
- NS Níquel satinado
- N Negro

■ **Medidas**

- Ref. 908: 180x133x4
- Ref. 907: 180x80x4



Bisagras Cuadradas de Hierro

REF. 313

■ **Acabados**

- Bicromatado
- L Latonado
- AB Antique brass
- NS Níquel satinado
- LM Laton mate



■ **Medidas**

- 2,5 x 2,5 mm.
- 3 x 3 mm.
- 3,5x3,5 mm.
- 4x4 mm.

- Con tirafondos

Bisagra de Seguridad de 5 nudos

REF. 105



Latonado



Niquel brillo



Lacado dorado



Pintada negro



Bicapa oro



Bicapa plata

Acabados

- Latonado
- N Niquel brillo
- LD Lacado dorado
- PN Pintada negro
- BO Bicapa oro
- BP Bicapa plata

Medidas

- Ref. 105-34: 2030x40 mm.
- Ref. 105-35: 2030x45 mm.
- Ref. 105-14: 2110x40 mm.
- Ref. 105-15: 2110x45 mm.

Pueden ser suministradas medidas más largas, hasta 2430 mm.



Bisagra de Seguridad de 5 nudos con Rodamiento

REF. 105R10

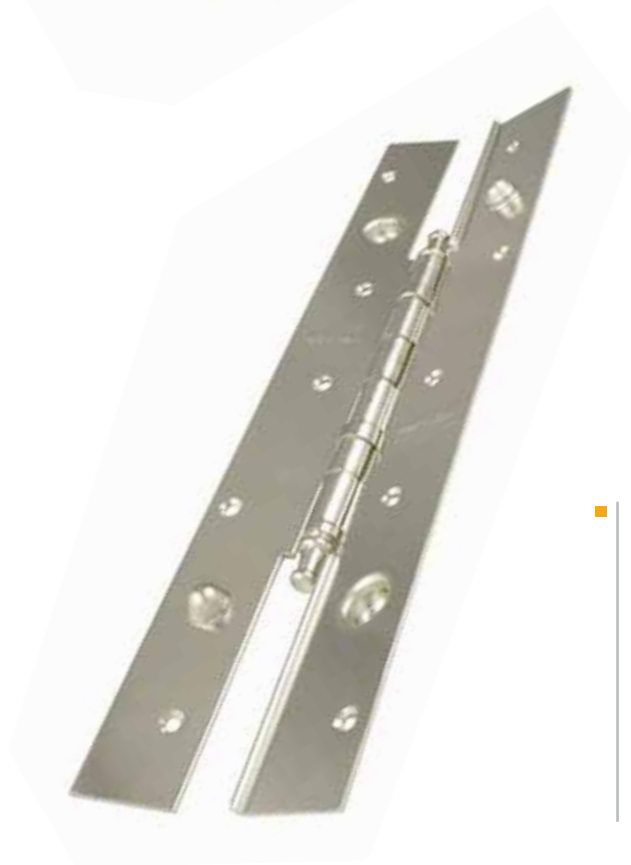

Latonado



Niquel brillo



Lacado dorado



Bicapa oro



Bicapa plata

Acabados

- Latonado
- N Niquel brillo
- LD Lacado dorado
- BO Bicapa oro
- BP Bicapa plata

Medidas

- Ref. 105R10-34: 2030x40 mm.
- Ref. 105R10-35: 2030x45 mm.
- Ref. 105R10-14: 2110x40 mm.
- Ref. 105R10-15: 2110x45 mm.

Pueden ser suministradas medidas más largas, hasta 2430 mm.

Bisagra de Piso con Resorte

REF. 10000

- **Acabados**
AB Antique brass
NS Níquel satinado
L Oro latonado





Pasadores

<i>Pasadores</i>32-33
<i>Pasador Mariposa</i>33
<i>Pasador de Acero Inox. 385</i>33
<i>Pasador 510</i>33
<i>Pasadores Embutidos</i>34
<i>Pasador 600</i>35
<i>Pasador 5000</i>35
<i>Cerraduras</i>36

Pasadores

REF. 454



- **Acabados**
- Bicromatado
- IOX Inoxidable 18/8
- LB Latonado barniz

• Agujero porta candado



REF. 455

	70	85	100	120
Ancho base	67 mm.	67 mm.	67 mm.	67 mm.
∅ Pasador	13 mm.	13 mm.	13 mm.	15 mm.
Agujeros Base	4 mm.	4 mm.	6 mm.	6 mm.



REF. 456



- **Acabados**
- Bicromatado
- IOX Inoxidable 18/8

• Agujero porta candado



REF. 457

	70	85	100	120
Ancho base	28 mm.	28 mm.	28 mm.	28 mm.
∅ Pasador	13 mm.	13 mm.	13 mm.	15 mm.



REF. 318



- **Acabados**
- Bicromatado
- IOX Inoxidable 18/8

	200	250	300	400*	500*	600*
Ancho base	67 mm.	67 mm.	67 mm.	67 mm.	67 mm.	67 mm.
Largo base	85 mm.	85 mm.	120 mm.	120 mm.	120 mm.	120 mm.
∅ Pasador	13 mm.	13 mm.	15 mm.	15 mm.	15 mm.	15 mm.
Agujeros Base	4 mm.	4 mm.	6 mm.	6 mm.	6 mm.	6 mm.

* Con dos puentes

Pasadores

REF. 319

Acabados

- Bicromatado
- IOX Inoxidable 18/8



	200	250	300	400*	500*	600*
Ancho base	28 mm.	28 mm.	28 mm.	28 mm.	28 mm.	28 mm.
Largo base	85 mm.	85 mm.	120 mm.	120 mm.	120 mm.	120 mm.
∅ Pasador	13 mm.	13 mm.	15 mm.	15 mm.	15 mm.	15 mm.

* Con dos puentes

Pasador Mariposa

REF. 384



* También disponibles con Puente Alto

Acabados

- Bicromatado
- L Latonado
- Z Zincado
- N Niquelado
- NE Negro
- LB Latonado barniz
- IOX Inoxidable 18/8

Medidas

- 25 mm.
- 30 mm.
- *35 mm.
- *40 mm.
- 50 mm.
- 60 mm.
- 70 mm.
- 85 mm.
- 100 mm.

Pasador de Acero Inoxidable 385

REF. 385



Acabados

- Inoxidable 18/8

Medidas

- 40 mm.
- 50 mm.

Pasador 510

REF. 510

Medidas

- 50 mm.
- 60 mm.
- 80 mm.
- 100 mm.
- 120 mm.
- 150 mm.
- 200 mm.
- 250 mm.
- 300 mm.
- 400 mm.



Incluye tirafondos

Acabados

- 510-O: Aluminio anodizado oro
- 510-P: Aluminio anodizado plata
- 510-B0: Aluminio anodizado bronce
- 510-B: Aluminio lacado blanco
- 510-N: Aluminio lacado negro

Pasadores Embutidos

REF. 500



Acabados

- Latonado barnizado
- CB Cromo brillo
- IOX Inoxidable 18/8
- L Latón
- NS Níquel Satinado

Medidas (largo)

- 160 mm.
- 200 mm.
- 250 mm.
- 300 mm.

REF. 501



Acabados

Inoxidable 18/8

Medidas

- 6" / 150 mm.
- 8" / 200 mm.
- 10" / 250 mm.

• Con tirafondos Inox.

REF. 502

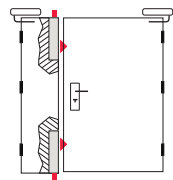
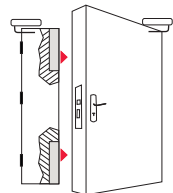

Acabados

Inoxidable 18/8

Medidas

6" / 150 mm.

• Con tirafondos Inox.

Pasador 600

REF. 600



Acabados

- Latón pulido
- NS Latón níquel satinado
- V Latón antique brass

Medidas

- 2" / 50 mm
- 3" / 80 mm
- 4" / 100 mm
- 5" / 125 mm
- 6" / 150 mm
- 8" / 200 mm

- Con tirafondos

Pasador 5000

REF. 5000



Acabados

- L Latón
- NS Níquel satinado
- V Antique brass

Medidas

- 4" / 100 mm.
- 6" / 150 mm.
- 8" / 200 mm.
- 10" / 250 mm.
- 12" / 300 mm.

- Con tirafondos

Cerraduras

REF. A27

■ **Medidas**

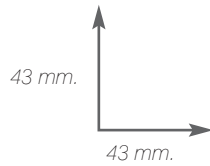

■ **Acabados**

- N Cromo brillo
- L Latonado
- AB Antique brass

- Con tirafondos

REF. 2380 Cuello 22 mm.



■ **Acabados**

- N Cromo brillo
- L Latonado
- AB Antique brass
- NE Negro

■ **Medidas**

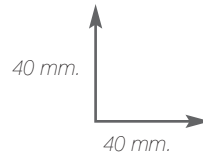

- Con tirafondos

- Con tirafondos

REF. 3390 Cuello 32 mm.

■ **Medidas**

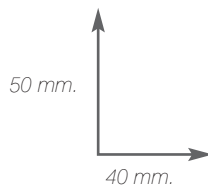

■ **Acabados**

- N Cromo brillo
- L Latonado
- AB Antique brass
- NE Negro

- Con tirafondos



Picaportes

<i>Picaporte Tubular</i>38
<i>Picaporte Unificado 2000</i>38
<i>Picaporte Unificado 4000</i>39
<i>Picaporte Muletilla</i>39

Picaporte Tubular

REF. PI-CC

REF. PI-CR



Acabados

Latonado
IOX Inoxidable 18/8

Medidas

35 mm.
45 mm.
60 mm.
70 mm.

Picaporte Unificado 2000

REF. PU2000

REF. PU2000S

• Silencioso



Acabados

Latonado
IOX Inoxidable
NS Niquel satinado
V Cuero

Medidas

50x47 mm.



Puede ser suministrado con canto cuadrado Ref. PU2000C

Picaporte Unificado 4000

REF. PU4000

REF. PU4000S

• Silencioso



- **Acabados**
 - Latonado
 - IOX Inoxidable 18/8
 - NS Niquel satinado
 - V Cuero
- **Medidas**
50x70 mm.



Picaporte Muletilla

REF. PM



- **Acabado**
 - Latonado
 - IOX Inoxidable 18/8
- **Medidas**
45 mm.
60 mm.







Manillas

<i>Manillas de Acero Inoxidable</i>	42
<i>Manillas de diseño en Acero Inoxidable</i>	43
<i>Manillas de Zamak y Aluminio</i>	43-44
<i>Manillas de Latón</i>	44
<i>Manillas Rústicas</i>	44
<i>Complementos: Bocallaves</i>	45
<i>Complementos: Muletillas y Desbloques Inox.</i>	45-46
<i>Complementos:</i>	
<i>Muletillas y Desbloques de Zamak</i>	46
<i>Manillones</i>	47
<i>Cuadrillos para manillas</i>	48
<i>Pomos de puerta</i>	48
<i>Pomos de puerta en blíster</i>	48
<i>Topes de puertas</i>	48

Manillas de Acero Inoxidable

REF. L-1

Variantes

- Ref. MRL-1: Roseta
- Ref. MPL-1: Placa con tirafondos
- Ref. MSPL-1: Placa sin tirafondos
- Ref. MPCL-1: Placa cuadrada
- Ref. MVL-1: Ventana



REF. L-2

Variantes

- Ref. MRL-2: Roseta
- Ref. MPL-2: Placa con tirafondos
- Ref. MSPL-2: Placa sin tirafondos
- Ref. MPCL-2: Placa cuadrada
- Ref. MVL-2: Ventana

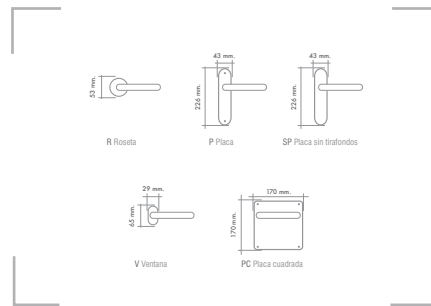

REF. L-3

Variantes

- Ref. MRL-3: Roseta
- Ref. MPL-3: Placa con tirafondos
- Ref. MSPL-3: Placa sin tirafondos
- Ref. MPCL-3: Placa cuadrada
- Ref. MVL-3: Ventana



REF. U-1

Variantes

- Ref. MRU-1: Roseta
- Ref. MPU-1: Placa con tirafondos
- Ref. MSPU-1: Placa sin tirafondos
- Ref. MPCU-1: Placa cuadrada
- Ref. MVU-1: Ventana



Manillas de diseño en Acero Inoxidable

REF. MRD-1

- Manilla maciza



REF. MPD-1



REF. MCLR-1

- Manilla cuadrada



- Manilla maciza con placa

Manillas de Zamak y Aluminio

REF. MZRD-1 y MARD-1

Zamak
MZRD-1

Aluminio
MARD-1



Manillas de Zamak y Aluminio

REF. MZRD-2

REF. MARD-2



Manillas de Latón

REF. MPO-1 y MPONS-1

Manillas Rústicas

REF. MRUS-1



Acabados

Ref. MPO-1: Latón pulido
Ref. MPONS-1: Níquel satinado



Acabados

Negro

Complementos: Bocallaves

REF. BOC-1



Acabado
Inoxidable Ø53



REF. BOC-2



Acabado
Inoxidable Ø53



REF. BOC-3



Acabado
Inoxidable



REF. BOC-C1



Acabado
Inoxidable



REF. BCZ-1



Acabado
Zamak



Complementos: Muletillas y Desbloques de Acero Inoxidable

REF. MUR-1



Diámetro
35 mm.
Acabado
Inoxidable



REF. MUR-3



Diámetro
53 mm.
Acabado
Inoxidable



Complementos: Muletillas y Desbloques de Acero Inoxidable

REF. MUR-2

REF. MUR-C1



- **Diámetro**
53 mm
- **Acabado**
Inoxidable
- **Muletilla**
Roja y verde



- **Medida**
53 mm
- **Acabado**
Inoxidable



Complementos: Muletillas y Desbloques de Zamak

REF. MUZR-1

REF. MURZ-2



- **Diámetro**
35 mm.
- **Acabado**
Niquel satinado



- **Diámetro**
50 mm.
- **Acabado**
Niquel satinado



Manillones

REF. MAN-1



Medidas

Ref. MAN-1/150: 150 mm.
 Ref. MAN-1/200: 200 mm.
 Ref. MAN-1/250: 250 mm.
 Ref. MAN-1/300: 300 mm

Acabados

Inoxidable



REF. MAN-2

Medidas

Ref. MAN-2/200: 200 mm.

Acabados

Inoxidable



REF. MAN-D1 y MAN-DA1



Medidas

200 mm.

Acabados

Ref. MAN-D1/200: Inoxidable
 Ref. MAN-DA1/200: Aluminio-Zamak



Cuadradillos para manillas

REF. C



Medidas
 Ref. C6x80: 6x80 mm.
 Ref. C8x80: 8x80 mm.
 Ref. C8x100: 8x100 mm.



Pomos de puerta

REF. 3350



Acabado
 Inoxidable
Diámetro
 85 mm.
Pomo
 70 mm.



Pomos de puerta en blister

REF. 607



Acabado
 SS Inoxidable
 AB Antique brass
 Oro

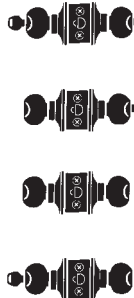

Topes de puerta

REF. 800



Medidas
 Ref. 8002030: 20x30 mm.
 Ref. 8002530: 25x30 mm.

Acabado
 Inoxidable



REF. 80045



Medidas
 45 mm.
Acabado
 Ref. 80045: Inoxidable
 Ref. 800Z45: Zamak





Pomos y tiradores

<i>Tiradores</i>	50-51
<i>Pomos de Acero Inoxidable</i>	51
<i>Tiradores de Embutir</i>	52
<i>Tiradores Rústicos</i>	53

Tiradores

REF. T12 y TA12



Acabados

Ref. T12: Inoxidable
Ref. TA12: Aluminio

Medidas

96 mm.
128 mm.
160 mm.
192 mm.
242 mm.
292 mm.
320 mm.

Diámetro

12 mm.

REF. TARCO

Acabados

Inoxidable

Medidas

96 mm.
128 mm.
160 mm.
192 mm.
224 mm.
320 mm.

Diámetro

10 mm.



REF. TC



Acabados

Inoxidable

Medidas

128 mm.
160 mm.
192 mm.
224 mm.
256 mm.
320 mm.

Sección

12,7x12,7 mm.

Tiradores

REF. TE



- **Acabados**
Inoxidable
- Medidas**
128 mm.
192 mm.
- Diámetro**
16 mm.



Pomos de Acero Inoxidable

REF. 100



- **Acabado**
Satinado
- Medidas**
20 mm.
25 mm.
30 mm.
35 mm.



REF. 101

REF. 102



- **Acabado**
Satinado
- Medidas**
15 mm.
20 mm.
25 mm.
30 mm.



- **Acabado**
Satinado
- Medidas**
12 mm.
16 mm.
20 mm.

REF. 103

Tiradores de Embutir

REF. 9005



Medidas
120x40 mm.

Acabados
Inoxidable



REF. 9006

• Circular

Medidas
65 mm.

Acabados
Inoxidable



REF. 9007

• Circular



Medidas
65 mm.

Acabados
Inoxidable



Tiradores Rústicos

REF. 9001



■ **Medidas**
90x30
Acabados
Negro

REF. 9000

■ **Medidas**
145x30
Acabados
Negro







Manillones y bisagras de cristal

<i>Manillones de Acero Inoxidable 18/8 AISI 304</i>	<i>56-59</i>
<i>Bisagras de cristal</i>	<i>60-61</i>
<i>Separadores de cristal de Acero Inox. 18/8 AISI 304</i>	<i>61</i>

REF. 10001



■ **Medidas**
Ref. 10001250: 25x250 mm.
Ref. 10001400: 32x400 mm.



REF. 10002

■ **Medidas**
Ref. 10002250: 25x250 mm.
Ref. 10002400: 32x400 mm.



Manillones de Acero Inoxidable 18/18 AISI 304

REF. 40003

Medidas

Ref. 40003400: 25x25x400 mm.



REF. 40001

Medidas

Ref. 40001400: 32x400 mm.



REF. 40002

Medidas

Ref. 40002400: 32x400 mm.



REF. 20001

- **Medidas**
 Ref. 20001250: 19x250 mm.
 Ref. 20001300: 19x300 mm.
 Ref. 20001400: 25x400 mm.
 Ref. 20001600: 25x600 mm.



REF. 20002

- **Medidas**
 Ref. 2000250: 19x250 mm.
 Ref. 20002300: 19x300 mm.
 Ref. 2002400: 25x400 mm.
 Ref. 2000260: 25x600 mm.



REF. 20003

- **Medidas**
 Ref. 20003250: 20x20x250 mm.
 Ref. 20003300: 20x20x300 mm.
 Ref. 20003400: 25x25x400 mm.
 Ref. 20003600: 25x25x600 mm.



Manillones de Acero Inoxidable 18/18 AISI 304

REF. 30002



Medidas

Ref. 30002300: 25x300 mm.
 Ref. 30002400: 32x400 mm.
 Ref. 30002500: 32x500 mm.



REF. 30003

Medidas

Ref. 30003300: 25x25x300 mm.
 Ref. 30003400: 32x32x400 mm.
 Ref. 30003500: 32x32x500 mm.



Bisagras de Cristal

REF. 20090A

REF. 20190A

• Cromo brillo

• Niquel satinado

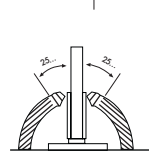
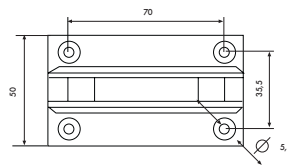
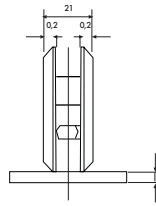
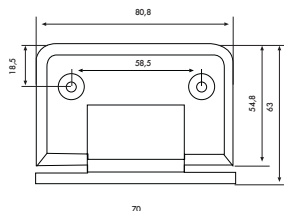

REF. 20090B

REFS. 20190B

• Cromo brillo

• Niquel satinado

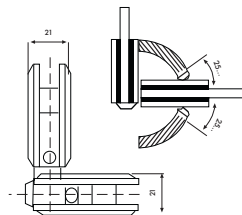
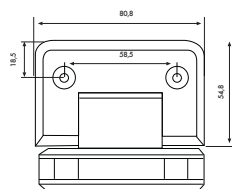

Bisagras de Cristal

REF. 200180

REF. 201180

• Cromo brillo

• Niquel satinado

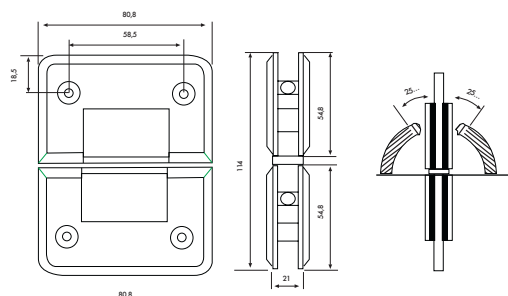

Separadores de Cristal de Acero Inoxidable 18/18 AISI 304

REFS. 43001 y 43002



Acabados
Inoxidable 18/8

Medidas
Ref. 43001: grande
Ref. 43002: pequeño



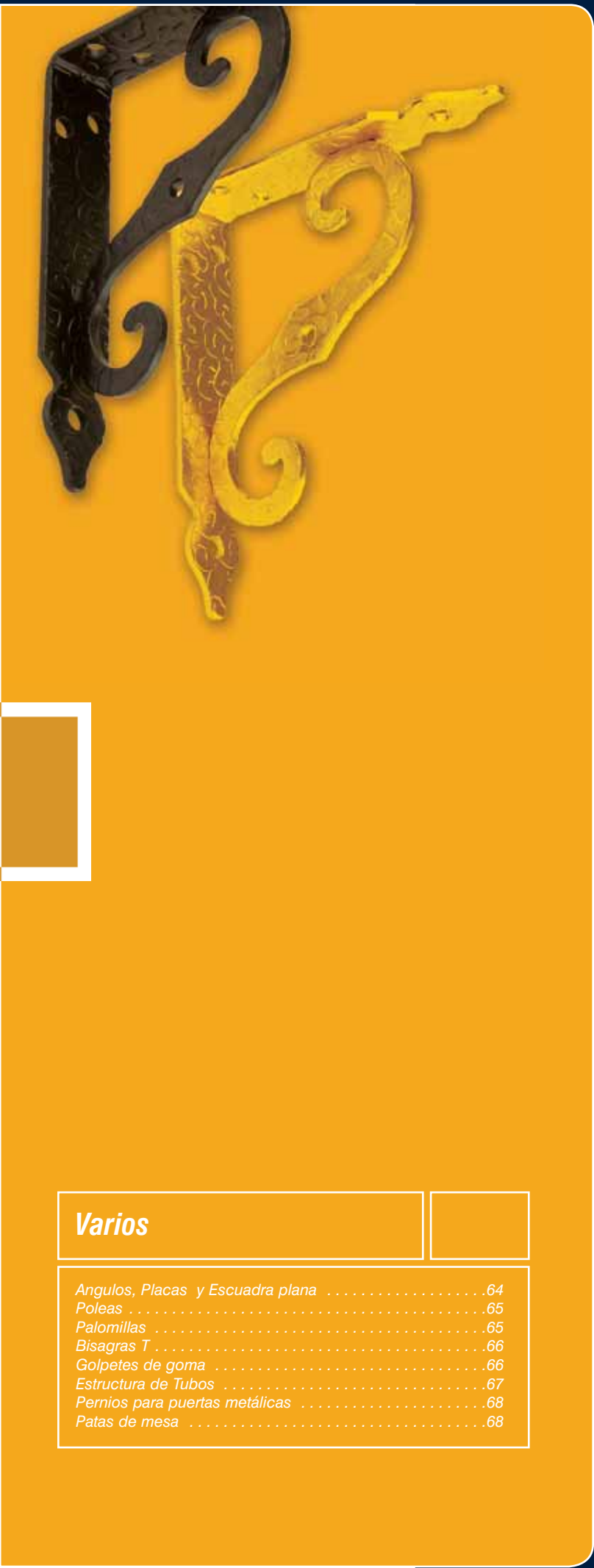

Varios



Angulos, Placas y Escuadra plana64
Poleas65
Palomillas65
Bisagras T66
Golpetes de goma66
Estructura de Tubos67
Pernios para puertas metálicas68
Patas de mesa68

Ángulos, Placas y Escuadra plana

REF. 732



Acabados

Bicromatado
Z Zincado

Medidas

20x20x18,5 mm.
30x30x18,5 mm.
40x40x19 mm.
50x50x19 mm.
60x60x19 mm.
80x80x19 mm.
100x100x19 mm.
120x120x19 mm.
140x140x19 mm.

REF. 731

Acabados

Bicromatado

Medidas

40x40x12 mm.
50x50x14 mm.
60x60x15 mm.
80x80x17 mm.
100x100x17 mm.
120x120x17 mm.



REF. 734



Acabados

Bicromatado

Medidas

40x18,5 mm.
60x18,5 mm.
80x18,5 mm.
100x19 mm.
120x19 mm.

Poleas

REFS.	MEDIDAS	RUEDA	SOPORTE
P1	40 cm.	Plástico	Tirafondo
P2	40 cm.	Plástico	Tornillo
P3	40 cm.	Zamak	Tirafondo
P4	40 cm.	Zamak	Tornillo
P5	60 cm.	Plástico	Tornillo
P6	60 cm.	Zamak	Tornillo



REFS.	MEDIDAS	RUEDAS	SOPORTE
P7	40 cm.	Plástico	Tirafondo
P8	40 cm.	Plástico	Tornillo
P9	40 cm.	Zamak	Tirafondo
P10	40 cm.	Zamak	Tornillo
P11	60 cm.	Plástico	Tornillo
P12	60 cm.	Zamak	Tornillo

Palomillas

REF. 800

• Palomilla ornamental



ACABADOS	MEDIDAS
N: Negro Epoxy	100x75 mm. (4"x3") 150x125 mm. (6"x5")
L: Latonado barniz	200x150 mm. (8"x6") 250x200 mm. (10"x8")

* Etiqueta individual con código de barras.
Suministrado con tacos y tirafondos

• Palomilla



■ **Acabados**
Blanco Epoxy

Medidas
100x75 mm. (4"x3")
125x100 mm. (5"x4")
150x125 mm. (6"x5")
175x150 mm. (7"x6")
200x150 mm. (8"x6")
225x175 mm. (9"x7")
250x200 mm. (10"x8")
300x250 mm. (12"x10")
350x300 mm. (14"x12")
400x350 mm. (16"x14")
450x400 mm. (18"x16")

* Etiqueta individual con código de barras.

Bisagras T

REF. 507



Acabados

- Bicromatado
- Z Zincado
- N Epoxy negro

Medidas

- 100x75 mm.
- 130x88 mm.
- 150x88 mm.
- 175x88 mm.
- 200x111 mm.
- 250x111 mm.
- 300x111 mm.

Golpetes de goma

REF. G-1



Acabados

- Bicromatado
- Z Zincado

Medidas

- 1mm de espesor

Estructura de Tubos

REF. Tubo IOX



• Tubo para cortina

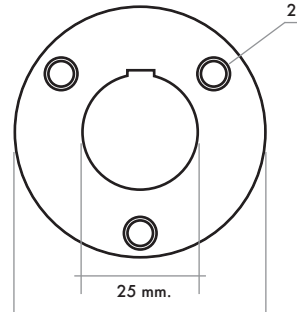

■ **Acabados**
Inoxidable

Medidas
1"x0,8x3000 mm. / 25x0,8x3000 mm.



• Estructura de cabina

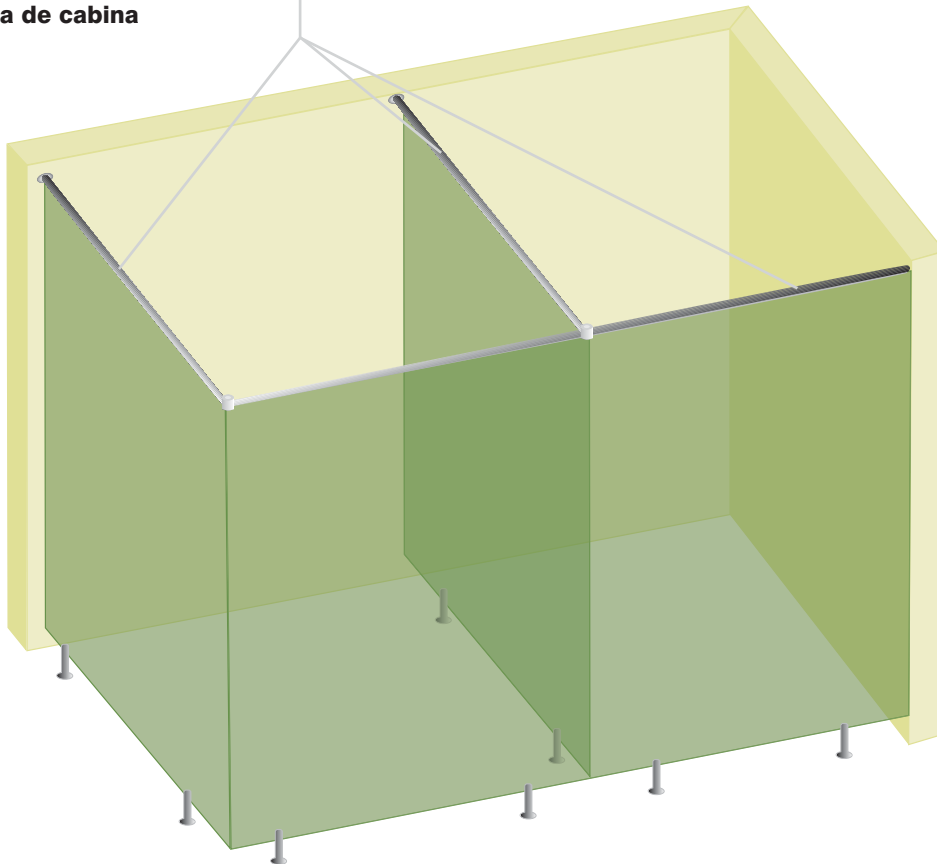

Pernios para puertas metálicas

REF. PP



REF.	A	B	ØD	C	E
PP1060	60	28	8	10	2
PP1280	80	38	16	12	2
PP1480	80	38	15	14	3
PP16100	100	48	14	16	3
PP18110	110	51	12	18	4
PP20120	120	56	15	20	5
PP25120	120	56	15	25	5
PP30150	150	67	22	30	6

* Pueden ser suministrados con pala corta

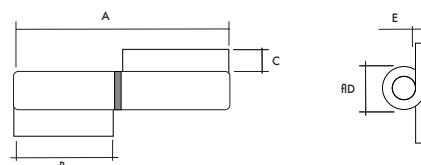

Patas de mesa

REFS. 2710 y 2870



Acabados

- B Blanco
- NS Niquel satinado

Medidas

- Ref. 2710: 710x60.1,2 mm.
- Ref. 2870: 870x60x1,2 mm.



AIDIMA
CERTIFICADO DE ENSAYOS

ENSAYOS	RESULTADO
<p>Montada sobre una puerta de tablero aglomerado de 730 x 470 mm y un espesor de 19 mm. Peso de la puerta: 4,8 kg.</p> <p>- Apdo. 8.1.1.- Fatiga sobre puertas giratorias. Masa sobre la puerta 3 kg., ciclos = 80.000 ciclos (ISO 7170-93) F. apertura y cierre <math>\leq 70\text{ N}</math>, para mantener el movimiento <math>\leq 45\text{ N}</math> (UNE 11023-2-92)</p> <p>- Apdo. 8.1.2.- Carga vertical sobre puertas abatibles. Carga aplicada = 35 kg., n° 10 ciclos, $\alpha = 35^\circ$ (ISO 7170-93)</p> <p>- Apdo. 8.3.2.- Carga estática horizontal sobre puerta abierta. F = 100 N, n° 10 veces, t = 10 seg (prEN 14074-00)</p>	<p>CORRECTO</p> <p>CORRECTO</p> <p>CORRECTO</p>

Paterna, 24 de febrero de 2003

AIDIMA
LABORATORIO DE ENSAYOS

Fdo. José Emilio Nuevalos
Responsable laboratorio mueble

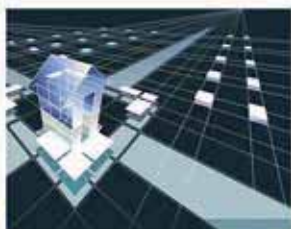
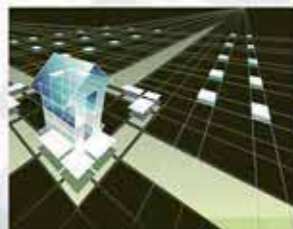
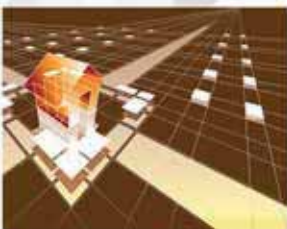
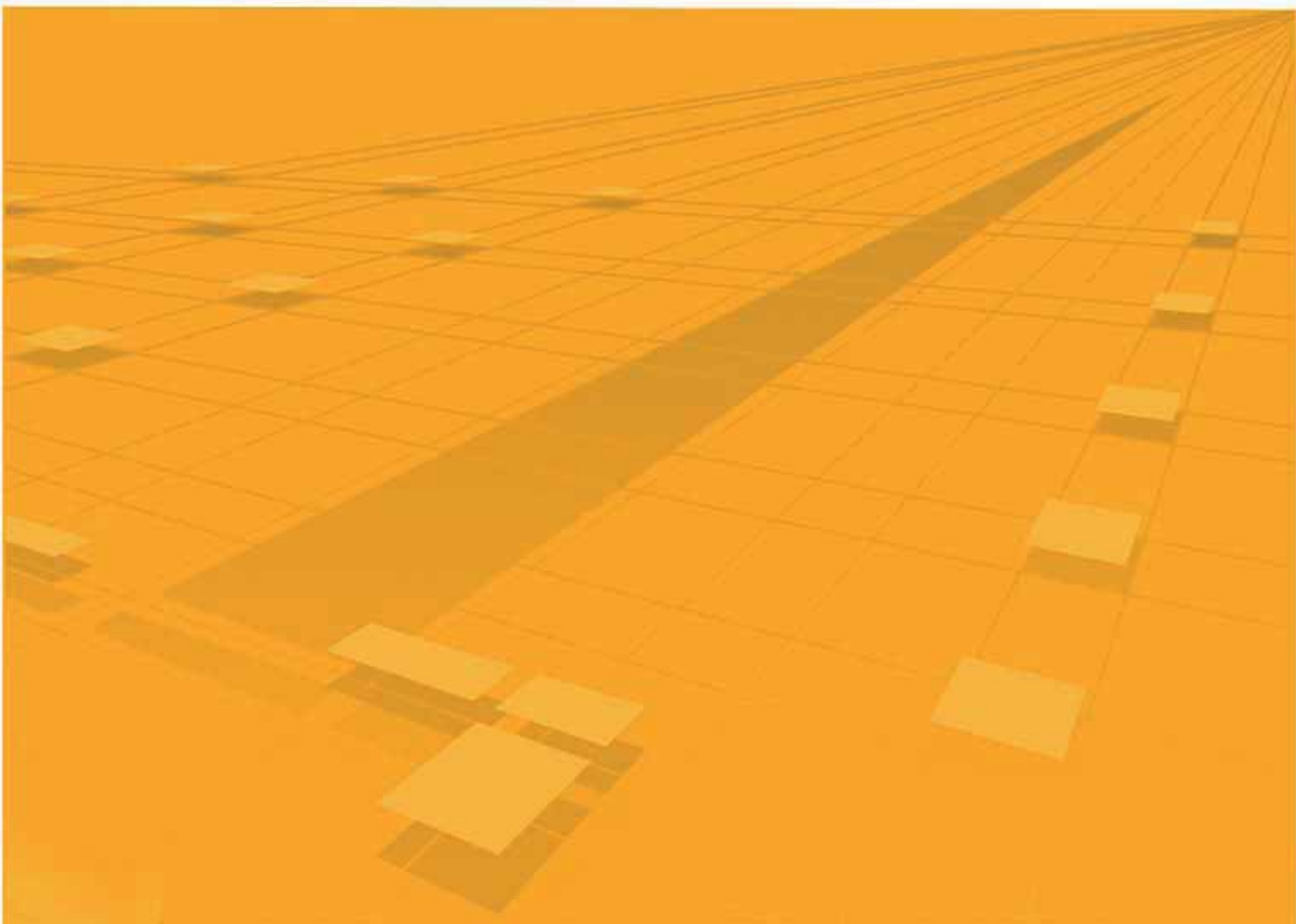

Obispo Otaduy, 25
Apdo. 93
20560 OÑATI (Gipuzkoa)
Tel.: (34) 943 780 918 • 943 781 753
Fax.: (34) 943 782 600
becusa@becusa.com
www.becusa.com

BECUSA