



***Tornillos para Chapa y
Carpintería de Aluminio/PVC***

***Vis à Tôle et pour
Profilés en Aluminium/PVC***

***Selftapping and Aluminium/PVC
Profiles Screws***

Tornillos para Chapa / Vis à Tôle / Selftapping Screws

DIN 7981



- Cabeza Alomada
- Philips (H)
- Punta C

- Tête Cylindrique Bombée
- Philips (H)
- Pointe C

- Pan Head
- Philips (H)
- C Point

			Precios / Prix / Prices (€/1000 u.)					Envasado / Conditionnement / Packing			
Diámetro Diamètre Diameter			Cincado Zingué Blanc Zinc Plated	Cincado ¹ CR III Zingué ¹ CR III Zinc ¹ CR III	Cincado Negro Zingué Noir Black Zinc Plated	Lacado Blanco Laquée Blanc White Lackered	Inox. A2 Inox. A2 Stainless steel A2	Caja Retail Box	Retractable Plastic Pack	Embalaje Pack Box	Bolsa Sachet Bag
			Caja / Carton Box	Bolsa / Sachet Bag	Caja / Carton Box	Caja / Carton Box	Caja / Carton Box	pcs	pcs	pcs	pcs
Ø 2,2 (Nº 2)	2,2 x 5	-	-	13,80	-	-	-	-	-	32.000	5.000
	2,2 x 6,5	1/4	13,80	13,80	-	-	-	1.000	8.000	32.000	5.000
	2,2 x 8	-	-	13,80	-	-	-	-	-	-	5.000
	2,2 x 9,5	3/8	13,80	13,80	-	-	-	1.000	8.000	32.000	5.000
	2,2 x 13	1/2	14,55	14,55	-	-	-	1.000	8.000	32.000	5.000
	2,2 x 16	5/8	15,00	15,00	-	-	-	1.000	8.000	32.000	5.000
Ø 2,9 (Nº 4)	2,9 x 5	-	-	11,70	-	-	-	-	-	-	5.000
	2,9 x 6,5	1/4	9,50	9,50	-	-	-	1.000	8.000	32.000	5.000
	2,9 x 8	-	-	9,15	-	-	-	-	-	-	5.000
	2,9 x 9,5	3/8	9,15	9,15	13,75	-	-	1.000	8.000	32.000	5.000
	2,9 x 13	1/2	10,35	10,35	15,55	-	-	1.000	4.000	16.000	5.000
	2,9 x 16	5/8	11,45	11,45	17,20	-	38,45	1.000	4.000	16.000	5.000
	2,9 x 19	3/4	13,00	13,00	19,50	-	42,35	1.000	4.000	16.000	2.500
	2,9 x 22	7/8	14,85	14,85	22,30	-	-	1.000	4.000	16.000	2.500
2,9 x 25	1	16,75	16,75	-	-	51,45	500	2.000	8.000	2.500	
Ø 3,3 (Nº 5)	3,3 x 6,5	1/4	-	12,20	-	-	-	-	-	-	5.000
	3,3 x 9,5	3/8	10,70	10,70	-	-	-	1.000	8.000	32.000	5.000
	3,3 x 13	1/2	-	11,50	-	-	-	-	-	-	5.000
	3,3 x 16	5/8	13,00	13,00	-	-	-	500	4.000	16.000	2.500
	3,3 x 19	3/4	-	15,60	-	-	-	-	-	-	2.500
	3,3 x 22	7/8	-	18,30	-	-	-	-	-	-	2.500
	3,3 x 25	1	20,15	20,15	-	-	-	500	2.000	8.000	2.500
Ø 3,5 (Nº 6)	3,5 x 6,5	1/4	12,15	12,15	18,25	-	41,15	1.000	8.000	32.000	5.000
	3,5 x 9,5	3/8	9,90	9,90	14,85	49,25	44,00	1.000	8.000	32.000	5.000
	3,5 x 13	1/2	10,60	10,60	15,90	-	44,00	500	4.000	16.000	2.500
	3,5 x 16	5/8	13,00	13,00	19,50	-	47,10	500	4.000	16.000	2.500
	3,5 x 19	3/4	15,70	15,70	23,55	-	51,65	500	2.000	8.000	2.500
	3,5 x 22	7/8	18,30	-	27,45	-	55,70	500	2.000	8.000	-
	3,5 x 25	1	20,15	20,15	30,25	-	62,45	250	2.000	8.000	1.250
	3,5 x 32	1-1/4	23,20	-	34,80	-	71,70	250	2.000	8.000	-
	3,5 x 38	1-1/2	26,75	-	40,15	-	-	250	1.000	4.000	-
Ø 3,9 (Nº 7)	3,9 x 6,5	1/4	13,40	-	-	-	-	500	4.000	16.000	-
	3,9 x 9,5	3/8	13,40	13,40	20,10	-	47,10	500	4.000	16.000	2.500
	3,9 x 13	1/2	14,55	14,55	21,85	-	51,90	500	4.000	16.000	2.500
	3,9 x 16	5/8	15,70	15,70	23,55	-	55,30	500	2.000	8.000	2.500
	3,9 x 19	3/4	17,85	17,85	26,80	-	56,90	500	2.000	8.000	2.500
	3,9 x 22	7/8	20,15	-	30,25	-	67,05	250	2.000	8.000	-
	3,9 x 25	1	21,75	21,75	32,65	-	74,70	250	2.000	8.000	1.250
	3,9 x 32	1-1/4	25,90	-	-	-	87,05	250	1.000	4.000	-
	3,9 x 38	1-1/2	28,95	-	-	-	97,75	250	1.000	4.000	-
	3,9 x 45	1-3/4	37,30	-	-	-	-	250	1.000	4.000	-

Tornillos para Chapa / Vis à Tôle / Selftapping Screws

DIN 7981

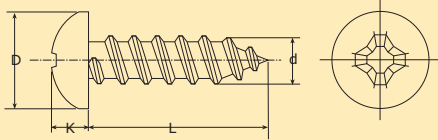

Ø	2,2	2,9	3,3	3,5	3,9	4,2	4,8	5,5
D	4,2	5,6	6,2	6,9	7,5	8,2	9,5	10,8
K	1,8	2,2	2,3	2,6	2,8	3,05	3,55	3,95
	H1	H1	H2	H2	H2	H2	H2	H3

Medidas en mm / Mesures en mm / Measures in mm

Diámetro Diamètre Diameter			Precios / Prix / Prices (€/1000 u.)					Envasado / Conditionnement / Packing				
			Cincado Zingué Blanc Zinc Plated	Cincado ¹ Zingué ¹ Zinc ¹	CR III CR III CR III	Cincado Negro Zingué Noir Black Zinc Plated	Lacado Blanco Laquée Blanc White Lackered	Inox. A2 Inox. A2 Stainless steel A2	Caja Retail Box	Retractil Plastic Pack	Embalaje Pack Box	Bolsa Sachet Bag
			Caja / Carton Box	Bolsa / Sachet Bag	Caja / Carton Box	Caja / Carton Box	Caja / Carton Box	pcs	pcs	pcs	pcs	
Ø 4,2 (N°8)	4,2 x 9,5	3/8	14,65	14,65	22,00	-	-	500	4.000	16.000	2.500	
	4,2 x 13	1/2	14,20	14,20	21,35	57,65	57,30	500	4.000	16.000	2.500	
	4,2 x 16	5/8	17,15	17,15	25,75	58,95	61,90	500	2.000	8.000	1.250	
	4,2 x 19	3/4	18,70	-	28,05	58,30	67,60	500	2.000	8.000	-	
	4,2 x 22	7/8	21,35	-	32,05	-	77,75	250	2.000	8.000	-	
	4,2 x 25	1	21,70	21,70	32,55	71,55	84,00	250	2.000	8.000	1.250	
	4,2 x 32	1-1/4	29,35	29,35	44,05	87,10	93,10	250	1.000	4.000	1.000	
	4,2 x 38	1-1/2	33,55	33,55	50,35	96,85	108,40	250	1.000	4.000	1.000	
	4,2 x 45	1-3/4	40,80	-	-	-	-	250	1.000	2.000	-	
	4,2 x 50	2	50,30	-	-	131,30	143,20	250	1.000	2.000	-	
4,2 x 60	2-3/8	64,00	-	-	150,70*	-	250	1.000	2.000	-		
4,2 x 70	2-3/4	73,15	-	-	-	-	250	1.000	2.000	-		
Ø 4,8 (N°10)	4,8 x 9,5	3/8	21,35	21,35	32,05*	-	-	500	2.000	8.000	1.250	
	4,8 x 13	1/2	21,35	21,35	32,05	63,20*	76,80	500	2.000	8.000	1.250	
	4,8 x 16	5/8	23,65	23,65	35,50	-	87,05	250	2.000	8.000	1.250	
	4,8 x 19	3/4	26,75	-	40,15	72,75*	94,15	250	2.000	8.000	1.250	
	4,8 x 22	7/8	28,95	-	43,45	-	102,40	250	2.000	8.000	-	
	4,8 x 25	1	27,90	27,90	41,85	85,00	110,45	250	1.000	4.000	1.000	
	4,8 x 32	1-1/4	36,20	36,20	54,30	100,20	127,90	250	1.000	4.000	1.000	
	4,8 x 38	1-1/2	41,15	41,15	61,75	112,40	139,15	250	1.000	2.000	500	
	4,8 x 45	1-3/4	53,00	-	-	-	157,40	250	1.000	2.000	-	
	4,8 x 50	2	60,60	-	90,90	155,30	182,70	250	1.000	2.000	-	
	4,8 x 60	2-3/8	75,05	-	112,60	178,85	208,75	250	1.000	2.000	-	
	4,8 x 70	2-3/4	85,20	-	127,80	249,65	270,70	100	400	800	-	
	4,8 x 80	3-1/4	114,55	-	171,85	320,40	326,05	100	400	800	-	
	4,8 x 90	3-5/8	146,80	-	220,20	-	423,30	100	400	800	-	
4,8 x 100	4	163,20	-	-	-	-	100	400	800	-		
4,8 x 110	4-3/8	194,20	-	-	-	-	100	400	800	-		
4,8 x 120	4-3/4	231,50	-	-	-	-	100	400	800	-		
4,8 x 140	5-5/8	388,45	-	-	-	-	100	400	400	-		
Ø 5,5 (N°12)	5,5 x 13	1/2	28,60	-	-	-	110,45	250	2.000	8.000	-	
	5,5 x 16	5/8	30,45	-	45,70	-	-	250	1.000	4.000	-	
	5,5 x 19	3/4	33,15	-	49,75	87,10	129,45	250	1.000	4.000	-	
	5,5 x 22	7/8	37,30	-	55,95	90,20	-	250	1.000	4.000	-	
	5,5 x 25	1	36,65	36,65	55,00	98,05	147,35	250	1.000	4.000	1.000	
	5,5 x 32	1-1/4	50,30	-	75,45	-	172,00	250	1.000	4.000	-	
	5,5 x 38	1-1/2	53,70	53,70	80,55	137,60	194,45	250	1.000	2.000	500	
	5,5 x 45	1-3/4	62,15	-	-	-	-	250	1.000	2.000	-	
	5,5 x 50	2	68,95	-	103,45	178,00	243,50	250	1.000	2.000	-	
	5,5 x 60	2-3/8	98,75	-	148,15	214,65	300,30	100	400	800	-	
	5,5 x 70	2-3/4	112,00	-	168,00	286,20	353,00	100	400	800	-	
	5,5 x 80	3-1/4	150,70	-	-	-	-	100	400	800	-	
	5,5 x 90	3-5/8	167,00	-	-	-	-	100	400	800	-	
	5,5 x 100	4	198,10	-	-	-	-	100	400	800	-	
	5,5 x 110	4-3/8	240,80	-	-	-	-	100	400	800	-	
	5,5 x 120	4-3/4	286,65	-	-	-	-	100	400	800	-	



* Hasta agotar existencias. * Fin serie. * End of stock.

Tornillos para Chapa / Vis à Tôle / Selftapping Screws

DIN 7981



- Cabeza Alomada
- Philips (H)
- Punta C

- Tête Cylindrique Bombée
- Philips (H)
- Pointe C

- Pan Head
- Philips (H)
- C Point

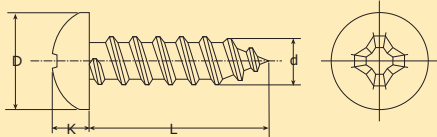

Ø	6,3
D	12,5
K	4,55
	H3

Medidas en mm / Mesures en mm / Measures in mm

			Precios / Prix / Prices (€/1000 u.)	Envasado / Conditionnement / Packing		
Diámetro Diamètre Diameter			Cincado Zingué Blanc Zinc Plated	Caja Retail Box	Retractil Plastic Pack	Embalaje Pack Box
			Caja / Carton / Box	pcs	pcs	pcs
Ø 6,3 (N° 14)	6,3 x 13	1/2	38,95	250	1.000	4.000
	6,3 x 16	5/8	43,10	250	1.000	4.000
	6,3 x 19	3/4	46,90	250	1.000	4.000
	6,3 x 25	1	57,55	250	1.000	4.000
	6,3 x 32	1-1/4	72,00	250	1.000	2.000
	6,3 x 38	1-1/2	79,70	250	1.000	2.000
	6,3 x 45	1-3/4	103,60	250	1.000	2.000
	6,3 x 50	2	108,25	250	1.000	2.000
	6,3 x 60	2-3/8	131,05	100	400	800
	6,3 x 70	2-3/4	144,40	100	400	800
6,3 x 80	3-1/4	213,60	100	400	800	
6,3 x 90	3-5/8	244,70	50	200	400	
6,3 x 100	4	289,00	50	200	400	

DIN 7981 F



- Punta F

- Pointe F

- F Point

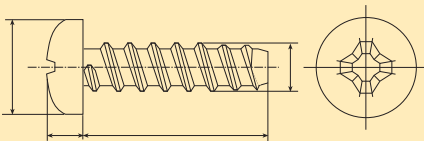

Diámetro	2,2	2,9	3,3	3,5	4,2
D	4,2	5,6	6,2	6,9	8,2
K	1,8	2,2	2,3	2,6	3,05
Punta Atorn.	H1	H1	H2	H2	H2

Medidas en mm / Mesures en mm / Measures in mm

			Precios / Prix / Prices (€/1000 u.)	Envasado / Conditionnement / Packing	
Diámetro Diamètre Diameter			Cincado CR III Zingué Blanc CR III Zinc Plated CR III	Bolsa Sachet Bag	
			Bolsa / Sachet / Bag	pcs	
Ø 2,2 (N° 2)	2,2 x 5	-	20,00	5.000	
	2,2 x 6,5	1/4	20,00	5.000	
	2,2 x 9,5	3/8	20,00	5.000	
Ø 2,9 (N° 4)	2,9 x 6,5	1/4	13,80	5.000	
	2,9 x 8	-	13,05	5.000	
	2,9 x 9,5	3/8	13,25	5.000	
Ø 3,3 (N° 5)	2,9 x 13	1/2	15,00	5.000	
	3,3 x 6,5	1/4	17,60	5.000	
Ø 3,5 (N° 6)	3,5 x 6,5	1/4	17,60	5.000	
	3,5 x 9,5	3/8	13,90	2.500	
	3,5 x 13	1/2	15,35	2.500	
Ø 4,2 (N° 8)	4,2 x 9,5	3/8	21,25	2.500	
	4,2 x 13	1/2	20,60	2.500	

Tornillos para Chapa / Vis à Tôle / Selftapping Screws

Ref. 7049 T

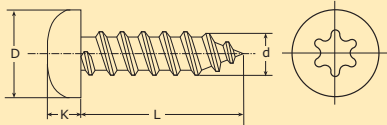
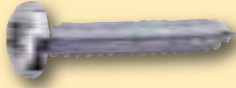

- Cabeza Alomada
- **TORX®**
- Punta C

- Tête Cylindrique Bombée
- **TORX®**
- Pointe C

- Pan Head
- **TORX®**
- Point C

Ø	3,5	4,2	4,8	5,5
D	7	8	9,5	11
K	2,6	3,1	3,7	4
	T15	T20	T25	T25

Medidas en mm / Mesures en mm / Measures in mm

			Precios / Prix / Prices (€/1000 u.)				Envasado / Conditionnement / Packing		
Diámetro Diamètre Diameter			Cincado ¹ Zingué Blanc ¹ Zinc Plated ¹	Cincado Negro Zingué Noir Black Zinc Plated	Lacado Blanco Laquée Blanc White Lackered ¹	Inox. A2 Inox. A2 Stainless steel A2	Caja Retail Box	Retractil Plastic Pack	Embalaje Pack Box
			Caja / Carton Box	Caja / Carton Box	Caja / Carton Box	Caja / Carton Box	pcs	pcs	pcs
Ø 3,5 (N°6)	3,5 x 9,5	3/8	14,30	20,70*	-	-	1.000	8.000	32.000
	3,5 x 13	1/2	15,25	-	-	51,05*	500	4.000	16.000
	3,5 x 16	5/8	-	-	-	55,75*	500	4.000	16.000
	3,5 x 19	3/4	22,55	-	-	-	500	2.000	8.000
	3,5 x 25	1	29,15	-	-	-	250	2.000	8.000
Ø 4,2 (N°8)	4,2 x 9,5	3/8	20,50	-	-	-	500	4.000	16.000
	4,2 x 13	1/2	21,20	-	-	-	500	4.000	16.000
	4,2 x 16	5/8	24,80	-	-	-	500	2.000	8.000
	4,2 x 19	3/4	26,95	-	-	-	500	2.000	8.000
	4,2 x 25	1	31,30	-	91,95*	97,80*	250	2.000	8.000
	4,2 x 32	1-1/4	42,35	61,45*	-	-	250	1.000	4.000
	4,2 x 38	1-1/2	48,40	-	-	-	250	1.000	4.000
	4,2 x 45	1-3/4	58,85	-	-	-	250	1.000	2.000
	4,2 x 50	2	72,70	-	-	-	250	1.000	2.000
Ø 4,8 (N°10)	4,8 x 13	1/2	30,80	44,70*	-	88,75*	500	2.000	8.000
	4,8 x 16	5/8	34,20	-	-	-	250	2.000	8.000
	4,8 x 19	3/4	38,55	-	-	108,95	500	2.000	8.000
	4,8 x 25	1	40,30	-	109,30*	127,55	250	1.000	4.000
	4,8 x 32	1-1/4	52,25	-	-	147,70	250	1.000	4.000
	4,8 x 38	1-1/2	59,00	86,30*	144,30*	161,00	250	1.000	2.000
	4,8 x 45	1-3/4	76,45	-	-	188,10*	250	1.000	2.000
	4,8 x 50	2	87,55	-	-	211,55	250	1.000	2.000
	4,8 x 60	2-3/8	108,35	-	-	241,60	250	1.000	2.000
	4,8 x 70	2-3/4	125,55	-	-	-	100	400	800
	4,8 x 80	3-1/4	165,40	-	-	-	100	400	800
	4,8 x 90	3-5/8	212,10	-	-	-	100	400	800
	4,8 x 100	4	235,75	-	-	-	50	200	800
	4,8 x 110	4-3/8	280,50	-	-	-	50	200	400
4,8 x 120	4-3/4	334,35	-	-	-	100	400	800	
Ø 5,5 (N°12)	5,5 x 19	3/4	47,90	-	-	149,80*	250	1.000	4.000
	5,5 x 25	1	52,95	76,75	125,85*	-	250	1.000	4.000
	5,5 x 32	1-1/4	72,70	-	-	198,70*	250	1.000	4.000
	5,5 x 38	1-1/2	77,55*	-	-	224,25*	250	1.000	2.000
	5,5 x 45	1-3/4	-	-	-	244,35*	250	1.000	2.000
	5,5 x 50	2	-	144,45*	-	281,15*	250	1.000	2.000
	5,5 x 60	2-3/8	141,95*	206,75*	-	-	100	400	800
	5,5 x 70	2-3/4	161,75	-	-	-	100	400	800
	5,5 x 90	3-5/8	241,25	-	-	-	50	200	400
	5,5 x 100	4	286,05	-	-	-	50	200	400



* Hasta agotar existencias. * Fin serie. * End of stock.

Tornillos para Chapa / Vis à Tôle / Selftapping Screws

Ref. 7049 S

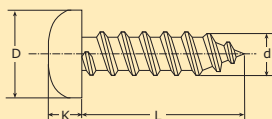

• Cabeza Alomada

• **sit.**

• Punta Forma C

• Tête Cylindrique Bombée

• **sit.**

• Pointe C

• Pan Head

• **sit.**

• C Point

Ø	3,5 ¹	4,2	4,8	5,5
D	7	8	9,5	11
K	2,8	3,1	3,7	4
	SIT20	SIT20	SIT25	SIT25

¹ INOX 3,5 SIT 10.

Medidas en mm / Mesures en mm / Measures in mm

EL TORNILLO SE AGUANTA EN LA PUNTA DEL ATORNILLADOR
LA VIS RESTE COLLÉE À L'EMBOUT DE VISSAGE SIT
THE SCREW STICKS ON THE SITO BITS



MEJOR TRANSMISIÓN DEL PAR DE APRIETE
AMÉLIORATION DE LA TRANSMISSION DU COUPLE DE VISSAGE
MORE EFFICIENT TORQUE TRANSFER

Diámetro Diamètre Diameter			Precios / Prix / Prices (€/1000 u.)			Envasado / Conditionnement / Packing		
			Cincado ¹ Zinc ¹ Zinc	CR III CR III CR III	Cincado Negro Zinc ¹ Black Zinc Plated	Inox. A2 Inox. A2 Stainless steel A2	Caja Retail Box	Retractable Plastic Pack
						pcs	pcs	pcs
Ø 3,5 (N° 6)	3,5 x 9,5	3/8	18,30	-	54,95	1.000	8.000	32.000
	3,5 x 13	1/2	20,85	-	55,05	500	4.000	16.000
	3,5 x 16	5/8	22,20	-	59,40	500	4.000	16.000
	3,5 x 19	3/4	26,10	-	65,20	500	2.000	8.000
	3,5 x 25	1	32,60	-	-	250	2.000	8.000
Ø 4,2 (N° 8)	4,2 x 9,5	3/8	24,80	32,25*	-	500	4.000	16.000
	4,2 x 13	1/2	26,10	34,95*	72,45	500	2.000	8.000
	4,2 x 16	5/8	27,35	38,95*	-	500	2.000	8.000
	4,2 x 19	3/4	29,55	41,70*	73,25	500	2.000	8.000
	4,2 x 25	1	36,30	47,05*	107,20	250	2.000	8.000
	4,2 x 32	1-1/4	48,35	68,55*	134,75	250	1.000	4.000
	4,2 x 38	1-1/2	53,70	75,25*	137,70	250	1.000	4.000
	4,2 x 45	1-3/4	64,45	-	-	250	1.000	2.000
	4,2 x 50	2	80,60	-	-	250	1.000	2.000
Ø 4,8 (N° 10)	4,8 x 13	1/2	34,95	-	98,50*	500	2.000	8.000
	4,8 x 16	5/8	38,95	-	110,05*	250	2.000	8.000
	4,8 x 19	3/4	44,35	64,45*	120,25	500	2.000	8.000
	4,8 x 25	1	47,05	67,20*	140,40	250	1.000	4.000
	4,8 x 32	1-1/4	61,80	87,30*	163,70	250	1.000	4.000
	4,8 x 38	1-1/2	69,85	99,35	178,20	250	1.000	2.000
	4,8 x 45	1-3/4	82,00	-	-	250	1.000	2.000
	4,8 x 50	2	91,35	-	233,15	250	1.000	2.000
	4,8 x 60	2-3/8	114,20	-	266,50	250	1.000	2.000
	4,8 x 70	2-3/4	134,30	-	345,35	100	400	800
	4,8 x 80	3-3/4	174,65	-	-	100	400	800
	4,8 x 90	3-5/8	214,95	-	-	100	400	800
	4,8 x 100	4	241,75	-	-	50	200	400
4,8 x 110	4-3/8	311,60	-	-	100	400	800	
4,8 x 120	4-3/4	349,25	-	-	100	400	800	
Ø 5,5 (N° 12)	5,5 x 19	3/4	56,40	-	165,10	250	1.000	4.000
	5,5 x 25	1	61,80	-	188,20	250	1.000	4.000
	5,5 x 32	1-1/4	68,65*	-	219,40	250	1.000	4.000
	5,5 x 38	1-1/2	82,15	-	248,10	250	1.000	2.000
	5,5 x 45	1-3/4	94,00*	-	-	250	1.000	2.000
	5,5 x 50	2	107,40	-	309,95	250	1.000	2.000
	5,5 x 60	2-3/8	147,70*	-	383,25	100	400	800
	5,5 x 70	2-3/4	174,65*	-	450,35	100	400	800
	5,5 x 80	3-3/4	214,95*	-	-	100	400	800
5,5 x 90	3-5/8	255,25*	-	-	50	200	400	
5,5 x 100	4	295,55*	-	-	100	400	800	



* Hasta agotar existencias. * Fin serie. * End of stock.

EL ASIENTO PERFECTO PARA ATORNILLAR FÁCIL

LE MEILLEURE EMPREINTE POUR UN VISSAGE FACILE

THE PERFECT DRIVE SYSTEM FOR AN EASY ASSEMBLY



*AW® Adolf Würth GmbH

- **Para montajes manuales con herramientas electroportátiles.**
El tornillo se aguanta en la punta SIT®. Óptima transmisión del par de apriete.
La geometría de los lóbulos permite un menor desgaste de las puntas.
Las paredes verticales anulan el efecto de expulsión durante al atornillado.
Atornillado sin presión axial. Menor consumo de batería.
La forma cónica interna de los lóbulos permiten un encaje perfecto.
Los tornillos con impronta SIT® son compatibles con puntas de atornillar SIT® y TORX®. El encaje perfecto se consigue únicamente con puntas SIT® originales.



Encaje Perfecto

- **Pour assemblages faites avec visseuses électriques portables.**
La vis reste collée à l'embout de visage SIT®. Transmission optimale du couple.
La géométrie des lobes offre une meilleure durée de vie de l'embout de vissage.
Les murs verticaux de l'empreinte, permettent de travailler sans augmenter la pression axiale sur la visseuse. Augmentation de la vie de la batterie.
La forme conique interne des lobes permet la fixation entre la vis et l'embout.
Les vis avec empreinte SIT® peuvent être vissées avec embouts de vissage SIT® et TORX®. Seulement avec les embouts SIT® la vis tient dans l'embout.



Encaje con Holgura

- **For manual assemblies with electric power tools.**
The screw sticks on the SIT® bit. Efficient torque transfer.
Longer tooling life due to the lobes geometry.
Reduced camout and end load due to the shape for the recess. Longuer battery life.
Stick-fit performance due to the internal conical walls.
Both SIT® and TORX® bits can be used with the SIT® screws. Only original SIT® bits offer the stick-fit effect.

Tornillos para Chapa / Vis à Tôle / Selftapping Screws

DIN 7982



- Cabeza Avellanada
- Philips (H)
- Punta Forma C

- Tête Fraisée
- Philips (H)
- Pointe C

- Countersunk Head
- Philips (H)
- C Point

			Precios / Prix / Prices (€/1000 u.)					Envasado / Conditionnement / Packing			
Diámetro Diamètre Diameter			Cincado Zingué Blanc Zinc Plated	Cincado ¹ CR III Zingué ¹ CR III Zinc ¹ CR III	Cincado Negro Zingué Noir Black Zinc Plated	Lacado Blanco Laquée Blanc White Lackered	Inox. A2 Inox. A2 Stainless steel A2	Caja Retail Box	Retractil Plastic Pack	Embalaje Pack Box	Bolsa Sachet Bag
			Caja / Carton Box	Bolsa / Sachet Bag	Caja / Carton Box	Caja / Carton Box	Caja / Carton Box	pcs	pcs	pcs	pcs
Ø 2,2 (Nº 2)	2,2 x 6,5	1/4	-	15,10	-	-	-	-	-	-	5.000
	2,2 x 9,5	3/8	-	15,10	-	-	-	-	-	-	5.000
	2,2 x 13	1/2	-	16,00	-	-	-	-	-	-	5.000
Ø 2,9 (Nº 4)	2,9 x 6,5	1/4	10,45	10,45	-	-	-	1.000	8.000	32.000	5.000
	2,9 x 9,5	3/8	10,05	10,05	-	-	-	1.000	8.000	32.000	5.000
	2,9 x 13	1/2	11,40	-	-	-	-	1.000	8.000	32.000	5.000
	2,9 x 16	5/8	-	12,60	-	-	-	-	-	-	5.000
	2,9 x 19	3/4	-	14,30	-	-	-	-	-	-	2.500
Ø 3,3 (Nº 5)	3,3 x 13	1/2	-	12,60	-	-	-	-	-	-	5.000
Ø 3,5 (Nº 6)	3,5 x 9,5	3/8	10,90	10,90	16,35	-	44,40	1.000	8.000	32.000	5.000
	3,5 x 13	1/2	11,65	11,65	-	-	42,30	500	4.000	16.000	2.500
	3,5 x 16	5/8	14,30	-	-	-	-	500	4.000	16.000	-
	3,5 x 19	3/4	17,25	-	-	-	46,85	500	2.000	8.000	-
	3,5 x 22	7/8	20,15	-	-	-	-	500	2.000	8.000	-
	3,5 x 25	1	22,15	-	-	-	-	250	2.000	8.000	-
	3,5 x 32	1-1/4	25,50	-	-	-	-	250	2.000	8.000	-
3,5 x 38	1-1/2	29,45	-	-	-	-	250	1.000	4.000	-	
Ø 3,9 (Nº 7)	3,9 x 9,5	3/8	14,75	-	22,15	-	-	500	4.000	16.000	-
	3,9 x 13	1/2	16,00	-	-	-	51,10	500	4.000	16.000	-
	3,9 x 16	5/8	17,25	-	-	-	-	500	4.000	16.000	-
	3,9 x 19	3/4	19,65	-	-	-	60,35	500	2.000	8.000	-
	3,9 x 22	7/8	22,15	-	-	-	-	250	2.000	8.000	-
	3,9 x 25	1	23,95	-	-	-	-	250	2.000	8.000	-
	3,9 x 32	1-1/4	28,50	-	-	-	-	250	1.000	4.000	-
	3,9 x 38	1-1/2	31,85	-	-	-	-	250	1.000	4.000	-
Ø 4,2 (Nº 8)	4,2 x 13	1/2	15,60	-	23,40	-	57,85	500	4.000	16.000	-
	4,2 x 16	5/8	18,85	-	28,30	-	62,50	500	2.000	8.000	-
	4,2 x 19	3/4	20,55	-	30,85	61,35	68,25	500	2.000	8.000	-
	4,2 x 22	7/8	23,50	-	-	-	-	250	2.000	8.000	-
	4,2 x 25	1	23,85	23,85	35,80	-	84,75	250	2.000	8.000	1.250
	4,2 x 32	1-1/4	32,30	-	-	-	94,00	250	1.000	4.000	-
	4,2 x 38	1-1/2	36,90	-	-	-	109,45	250	1.000	4.000	-
	4,2 x 45	1-3/4	44,90	-	-	-	-	250	1.000	4.000	-
	4,2 x 50	2	55,35	-	-	-	133,95	250	1.000	2.000	-



Tornillos para Chapa / Vis à Tôle / Selftapping Screws

DIN 7982

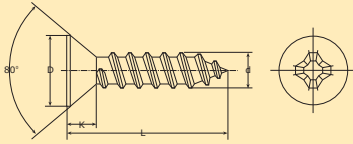

Ø	2,2	2,9	3,3	3,5	3,9	4,2
D	4,3	5,5	6,1	6,8	7,5	8,1
K	1,3	1,7	1,9	2,1	2,3	2,5
	H1	H1	H2	H2	H2	H2

Medidas en mm / Mesures en mm / Mesures in mm

			Precios / Prix / Prices (€/1000 u.)					Envasado / Conditionnement / Packing			
Diámetro Diamètre Diameter			Cincado Zingué Blanc Zinc Plated	Cincado ¹ CR III Zingué ¹ CR III Zinc ¹ CR III	Cincado Negro Zingué Noir Black Zinc Plated	Lacado Blanco Laquée Blanc White Lackered	Inox. A2 Inox. A2 Stainless steel A2	Caja Retail Box	Retractil Plastic Pack	Embalaje Pack Box	Bolsa Sachet Bag
			Caja / Carton Box	Bolsa / Sachet Bag	Caja / Carton Box	Caja / Carton Box	Caja / Carton Box	pcs	pcs	pcs	pcs
Ø 4,8 (N° 10)	4,8 x 13	1/2	23,50	-	-	-	81,20	500	2.000	8.000	-
	4,8 x 16	5/8	26,00	-	-	-	-	250	2.000	8.000	-
	4,8 x 19	3/4	29,45	-	-	-	99,60	250	2.000	8.000	-
	4,8 x 22	7/8	31,85	-	-	-	-	250	2.000	8.000	-
	4,8x 25	1	30,70	-	-	-	116,80	250	1.000	4.000	-
	4,8 x 32	1-1/4	39,80	-	-	-	135,30	250	1.000	4.000	-
	4,8 x 38	1-1/2	45,25	-	-	-	147,20	250	1.000	2.000	-
	4,8 x 45	1-3/4	58,30	-	-	-	166,50	250	1.000	2.000	-
	4,8 x 50	2	66,65	-	-	-	-	250	1.000	2.000	-
Ø 5,5 (N° 12)	4,8 x 60	2-3/8	82,55	-	-	-	-	250	1.000	2.000	-
	5,5 x 13	1/2	-	-	-	-	116,80*	250	2.000	8.000	-
	5,5 x 19	3/4	36,45	-	-	-	-	250	1.000	4.000	-
	5,5 x 25	1	40,30	-	-	-	155,85	250	1.000	4.000	-
	5,5 x 32	1-1/4	55,35	-	-	-	-	250	1.000	4.000	-
	5,5 x 38	1-1/2	59,05	-	-	-	-	250	1.000	2.000	-
	5,5 x 50	2	75,85	-	-	-	-	250	1.000	2.000	-
5,5 x 60	2-3/8	108,65	-	-	-	-	100	400	800	-	



* Hasta agotar existencias. * Fin serie. * End of stock.

DIN 7982 F

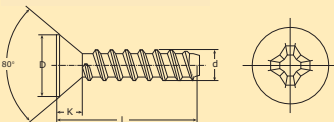

Punta F

Ø	2,9
D	5,5
K	1,7
	H1

Medidas en mm / Mesures en mm / Mesures in mm

Pointe F

F Point

			Precios / Prix / Prices (€/1000 u.)	Envasado / Conditionnement / Packing
Diámetro Diamètre Diameter			Cincado ¹ CR III Zingué ¹ CR III Zinc ¹ CR III	Bolsa Sachet Bag
				pcs
Ø 2,9 (N° 4)	2,9 x 13	1/2	15,90*	5.000

* Hasta agotar existencias. * Fin serie. * End of stock.

Tornillos para Chapa / Vis à Tôle / Selftapping Screws

Ref. 7050 T

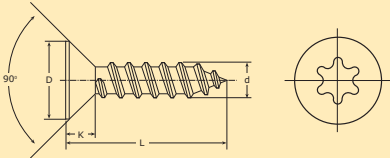

- Cabeza Avellanada
- **TORX®**
- Punta Forma C

- Tête Fraisée
- **TORX®**
- Pointe C

- Countersunk Head
- **TORX®**
- C Point

Ø	3,5	4,2	4,8
D	7,3	8,4	9,3
K	2,35	2,6	2,8
	T15	T20	T25

Medidas en mm / Mesures en mm / Measures in mm

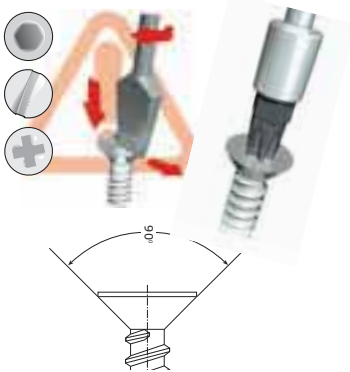

Los tornillos cabeza avellanada según norma ISO 7050, tienen un ángulo de cabeza de 90°. Según la norma DIN 7982 son de 82°.
Les vis tête fraisée selon norme ISO 7050, ont un angle de tête de 90°. Selon la norme DIN 7982 l'angle est de 82°.
The angle for the countersunk head screws as per norm ISO 7050 is 90°. As per norm DIN 7982, the head is 82°.

			Precios / Prix / Prices (€/1000 u.)		Envasado / Conditionnement / Packing			
Diámetro Diamètre Diameter			Cincado ¹ Zingué ² Zinc ³	CR III CR III CR III	Cincado Negro Zingué Noir Black Zinc Plated	Caja Retail Box	Retractable Plastic Pack	Embalaje Pack Box
			pcs	pcs	pcs			
Ø 3,5 (N°6)	3,5 x 9,5	3/8	-	-	21,90*	1.000	8.000	32.000
	4,2 x 13	1/2	21,75	-	-	500	4.000	16.000
	4,2 x 16	5/8	26,35	-	-	500	2.000	8.000
Ø 4,2 (N°8)	4,2 x 19	3/4	-	-	41,45*	500	2.000	8.000
	4,2 x 25	1	-	-	48,15*	250	2.000	8.000
	4,2 x 32	1-1/4	44,90*	-	-	250	1.000	4.000
	4,8 x 19	3/4	40,90*	-	-	250	2.000	8.000
Ø 4,8 (N°10)	4,8 x 32	1-1/4	55,45*	-	-	250	1.000	4.000



* Hasta agotar existencias. * Fin serie. * End of stock.

Ref. 7061 S

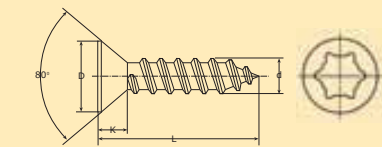

- Cabeza Avellanada
- **sit.**
- Punta C

- Tête Fraisée
- **sit.**
- Pointe C

- Countersunk Head
- **sit.**
- C Point

Ø	3,5	4,2	4,8
D	7	8	9
K	3,1	3,6	3,9
	SIT10	SIT20	SIT20

Medidas en mm / Mesures en mm / Measures in mm

			Precios / Prix / Prices (€/1000 u.)		Envasado / Conditionnement / Packing		
Diámetro Diamètre Diameter			Cincado Zingué Blanc Zinc Plated		Caja Retail Box	Retractable Plastic Pack	Embalaje Pack Box
			pcs	pcs	pcs	pcs	
Ø 3,5 (N°6)	3,5 x 9,5	3/8	21,55*	-	1.000	8.000	32.000
	3,5 x 13	1/2	22,85*	-	1.000	8.000	32.000
	3,5 x 16	5/8	25,05*	-	500	4.000	16.000
	3,5 x 19	3/4	29,65*	-	500	2.000	8.000
Ø 4,2 (N°8)	4,2 x 13	1/2	30,95*	-	500	4.000	16.000
	4,2 x 16	5/8	31,95*	-	500	2.000	8.000
	4,2 x 19	3/4	35,50*	-	500	2.000	8.000
	4,2 x 25	1	42,95*	-	250	2.000	8.000
	4,2 x 32	1-1/4	45,65*	-	250	1.000	4.000
Ø 4,8 (N°10)	4,8 x 19	3/4	47,05*	-	250	2.000	8.000
	4,8 x 25	1	53,70*	-	250	1.000	4.000
	4,8 x 32	1-1/4	65,80*	-	250	1.000	4.000
	4,8 x 38	1-1/2	73,90*	-	250	1.000	2.000

* Hasta agotar existencias. * Fin serie. * End of stock.

Tornillos para Chapa / Vis à Tôle / Selftapping Screws

DIN 7983



- Cabeza Gota Sebo
- Philips (H)
- Punta Forma C

- Tête Fraisée Bombée
- Philips (H)
- Pointe C

- Raised Countersunk Head
- Philips (H)
- C Point

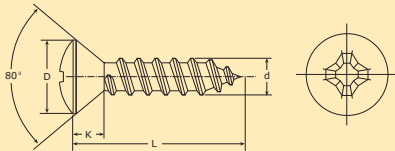

Ø	2,2	2,9	3,5	3,9	4,2	4,8	5,5
D	4,3	5,5	6,8	7,5	8,1	9,5	10,8
K	1,3	1,7	2,1	2,3	2,5	3,0	3,4
	H1	H1	H2	H2	H2	H2	H3

Medidas en mm / Mesures en mm / Measures in mm

			Precios / Prix / Prices (€/1000 u.)			Envasado / Conditionnement / Packing			
Diámetro Diamètre Diameter			Cincado ¹ Zincé ¹ Zinc ¹	CR III CR III CR III	Cincado Negro Zingué Noir Black Zinc Plated	Caja Retail Box	Retractil Plastic Pack	Embalaje Pack Box	Bolsa Sachet Bag
			Caja / Carton Box	Bolsa / Sachet Bag	Caja / Carton Box	pcs	pcs	pcs	pcs
Ø 2,2 (N°2)	2,2 x 6,5	1/4	-	17,85*	-	-	-	-	5.000
	2,2 x 9,5	3/8	-	17,85*	-	-	-	-	5.000
Ø 2,9 (N°4)	2,9 x 6,5	1/4	-	12,35	-	-	-	-	5.000
	2,9 x 9,5	3/8	-	11,95	18,00	1.000	8.000	32.000	5.000
	2,9 x 13	1/2	-	13,40	-	-	-	-	5.000
	2,9 x 16	5/8	-	14,90	22,50	1.000	4.000	16.000	5.000
	2,9 x 19	3/4	16,90	-	25,35	1.000	4.000	16.000	-
	2,9 x 25	1	21,80	21,80	-	500	2.000	8.000	2.500
Ø 3,5 (N°6)	3,5 x 13	1/2	-	13,75	20,75*	500	4.000	16.000	2.500
	3,5 x 16	5/8	16,90	-	25,35	500	4.000	16.000	2.500
	3,5 x 19	3/4	20,40	-	30,60	500	2.000	8.000	-
	3,5 x 22	7/8	-	23,75	-	-	-	-	2.500
	3,5 x 25	1	26,20	-	39,30	250	2.000	8.000	-
3,5 x 32	1-1/4	-	30,15	-	-	-	-	1.250	
Ø 3,9 (N°7)	3,9 x 9,5	3/8	-	17,30*	-	-	-	-	2.500
	3,9 x 16	5/8	20,40	-	30,60	500	4.000	16.000	-
	3,9 x 19	3/4	-	23,20	35,20	500	2.000	8.000	2.500
	3,9 x 22	7/8	-	-	39,65	250	2.000	8.000	-
3,9 x 25	1	28,30	-	-	250	2.000	8.000	-	
Ø 4,2 (N°8)	4,2 x 19	3/4	24,30	-	36,45	500	2.000	8.000	-
	4,2 x 22	7/8	27,75	-	41,65	250	2.000	8.000	-
	4,2 x 25	1	28,20	-	42,30	250	2.000	8.000	-
	4,2 x 32	1-1/4	38,15	-	-	250	1.000	4.000	-
	4,2 x 38	1-1/2	43,60	-	65,40	250	1.000	4.000	-
4,2 x 45	1-3/4	53,05	-	-	250	1.000	4.000	-	
Ø 4,8 (N°10)	4,8 x 16	5/8	-	30,80	-	-	-	-	1.250
	4,8 x 19	3/4	34,80	-	52,20*	250	2.000	8.000	-
	4,8 x 25	1	36,25	-	54,40	250	1.000	4.000	-
	4,8 x 32	1-1/4	47,05	-	-	250	1.000	4.000	-
	4,8 x 38	1-1/2	53,50	-	80,25*	250	1.000	2.000	-
	4,8 x 45	1-3/4	68,90	-	-	250	1.000	2.000	-
Ø 5,5 (N°12)	5,5 x 25	1	47,65	-	-	250	1.000	4.000	-



* Hasta agotar existencias.

Tornillos para Chapa / Vis à Tôle / Selftapping Screws

Ref. CH 88 H

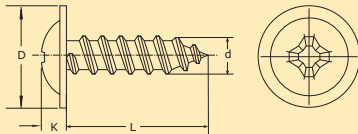

- Cabeza Alomada Ancha
- Philips (H)
- Punta Forma C

- Tête Cylindrique Avec Embase
- Philips (H)
- Pointe C

- Pan Head With Washer
- Philips (H)
- C Point

Ø	3,9	4,2	4,8
D	10,2	11	11,7
K	2,2	2,6	2,9
	H2	H2	H2

Medidas en mm / Mesures en mm / Measures in mm



			Precios / Prix / Prices (€/1000 u.)		Envasado / Conditionnement / Packing			
Diámetro Diamètre Diameter			Cincado ¹ Zingué ¹ Zinc ¹	CR III CR III CR III	Cincado Negro Zingué Noir Black Zinc Plated	Caja Retail Box	Retractable Plastic Pack	Embalaje Pack Box
						pcs	pcs	pcs
Ø 3,9 (Nº7)	3,9 x 9,5	3/8	22,40	32,40	500	4.000	16.000	
	3,9 x 13	1/2	24,20	35,10	500	2.000	8.000	
	3,9 x 16	5/8	27,50	39,90	500	2.000	8.000	
	3,9 x 19	3/4	-	40,35	500	2.000	8.000	
	3,9 x 25	1	-	52,95	250	1.000	4.000	
Ø 4,2 (Nº8)	4,2 x 9,5	3/8	31,00	44,90	500	2.000	8.000	
	4,2 x 13	1/2	28,35	41,05	500	2.000	8.000	
	4,2 x 16	5/8	30,10	43,55	500	2.000	8.000	
	4,2 x 19	3/4	32,45	47,05	500	2.000	8.000	
	4,2 x 22	7/8	-	55,45	250	1.000	4.000	
	4,2 x 25	1	39,20	56,85	250	1.000	4.000	
Ø 4,8 (Nº10)	4,8 x 13	1/2	36,50	52,95	500	2.000	8.000	
	4,8 x 16	5/8	40,05	58,15	250	1.000	4.000	
	4,8 x 19	3/4	44,20	64,15	250	1.000	4.000	
	4,8 x 22	7/8	-	68,15	250	1.000	4.000	
	4,8 x 25	1	51,50	74,60	250	1.000	4.000	
	4,8 x 32	1-1/4	62,50	90,60	250	1.000	4.000	
	4,8 x 38	1-1/2	68,75	99,70	250	1.000	2.000	



Tornillos para Chapa / Vis à Tôle / Selftapping Screws

Ref. 75 HA

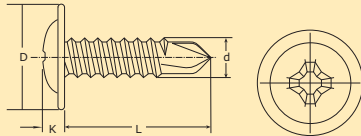

- Cabeza Alomada Ancha
- Philips (H)
- Autotaladrante

- Tête Cylindrique Avec Embase
- Philips (H)
- Autoperceuse

- Pan Head with Washer
- Philips (H)
- Selfdrilling Screw

Ø	4,2
D	11
K	2,6
	H2

Medidas en mm / Mesures en mm / Measures in mm

Ventajas:

- Útil en los casos en que se necesita repartir presiones, o trabajar sobre agujeros sobredimensionados.
- Evita la utilización de arandelas planas, lo que supone un ahorro de coste y mayor facilidad de montaje.

Avantages:

- Elle permet de réduire la pression sous tête, et de travailler avec le diamètre de trou surdimensionné.
- La forme de la tête remplace une rondelle, ce qui permet une réduction des coûts et rend l'assemblage plus facile.

Advantages:

- To be used in oversized holes or to reduce the pressure under head.
- Avoids the use of washer, making the assembly easier, and therefore reducing overall costs.

Aplicaciones:

- Para fijación de plástico, chapas finas, aglomerado, piezas con agujeros grandes.
- Sobre chapas, perfiles de aluminio o tacos de nylon.

Applications:

- Pour la fixation de pièces en plastique, tôle fine et bois aggloméré et possédant des trous surdimensionnés.

Applications:

- To be used on plastics, thin plates, chipboard, soft wood, or pieces with oversized holes.

Tela sobre Aluminio
Tissue sur Aluminium
Textile on Aluminium



Metacrilato sobre metal
Metacrilate sur tôle
Methacrylate on metal



Diámetro Diamètre Diameter			Precios / Prix / Prices (€/1000 u.)		Envasado / Conditionnement / Packing		
			Cincado Zingué Blanc Zinc Plated	Cincado Negro Zingué Noir Black Zinc Plated	Caja Retail Box	Retractil Plastic Pack	Embalaje Pack Box
			pcs	pcs	pcs	pcs	pcs
Ø 4,2 (Nº8)	4,2 x 13	1/2	33,40	50,40	500	2.000	8.000
	4,2 x 16	5/8	34,65	53,80	500	2.000	8.000
	4,2 x 19	3/4	37,80	64,90	250	2.000	8.000
	4,2 x 25	1	41,60	72,45	250	1.000	4.000
	4,2 x 32	1-1/4	48,50	85,25	250	1.000	4.000

Tornillos Autotaladrantes para Chapa / Vis Autoperceuses / Selfdrilling Screws

DIN 7504-N

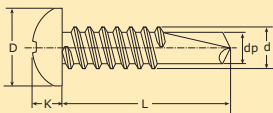

• Cabeza Alomada

• Philips (H)

• Tête Cylindrique Bombée

• Philips (H)

• Pan Head

• Philips (H)

Ø	3,5	3,9	4,2	4,8	5,5
D	6,9	7,5	8,2	9,5	10,8
K	2,6	2,8	3,05	3,55	3,95
dp Max	2,8	3,2	3,6	4,1	4,8
	H2	H2	H2	H2	H3

Medidas en mm / Mesures en mm / Measures in mm

			Precios / Prix / Prices (€/1000 u.)				Envasado / Conditionnement / Packing		
Diámetro Diamètre Diameter			Cincado Zingué Blanc Zinc Plated	Cincado Negro Zingué Noir Black Zinc Plated	Lacado Blanco Laquée Blanc White Lackered	Inox. A2 ¹ Inox. A2 ¹ Stainless steel A2 ¹	Caja Retail Box	Retrctil Plastic Pack	Embalaje Pack Box
			Caja / Carton Box	Bolsa / Sachtet Bag	Caja / Carton Box	Caja / Carton Box	pcs	pcs	pcs
Ø 3,5 (Nº6)	3,5 x 9,5	3/8	10,30	15,45	47,10	65,45	1.000	8.000	32.000
	3,5 x 11	-	12,40	-	-	-	1.000	4.000	16.000
	3,5 x 13	1/2	12,95	19,45	49,25	77,10	500	4.000	16.000
	3,5 x 16	5/8	13,40	20,10	-	86,75	500	4.000	16.000
	3,5 x 19	3/4	14,70	22,05	-	94,00	500	2.000	8.000
	3,5 x 22	7/8	18,25	-	-	-	500	2.000	8.000
	3,5 x 25	1	19,25	28,90	-	-	250	2.000	8.000
Ø 3,9 (Nº7)	3,5 x 32	1-1/4	22,10	-	-	-	250	2.000	8.000
	3,9 x 13	1/2	15,30	22,95	-	-	500	4.000	16.000
	3,9 x 16	5/8	15,70	23,55	-	91,60	500	2.000	8.000
	3,9 x 19	3/4	19,40	-	-	96,45	500	2.000	8.000
Ø 4,2 (Nº8)	3,9 x 25	1	23,80	-	-	108,50	250	2.000	8.000
	3,9 x 32	1-1/4	26,75	-	-	-	250	1.000	4.000
	4,2 x 13	1/2	15,70	23,55	56,20	95,05	500	4.000	16.000
	4,2 x 16	5/8	17,65	26,50	57,65	99,50	500	2.000	8.000
	4,2 x 19	3/4	18,90	28,35	59,25	105,40	500	2.000	8.000
	4,2 x 22	7/8	22,35	-	85,65	-	250	2.000	8.000
	4,2 x 25	1	23,55	33,55	-	126,40	250	2.000	8.000
Ø 4,8 (Nº10)	4,2 x 32	1-1/4	30,60	45,90	-	-	250	1.000	4.000
	4,2 x 38	1-1/2	31,75	47,65	-	-	250	1.000	4.000
	4,2 x 50	2	40,35	-	-	-	250	1.000	2.000
	4,8 x 13	1/2	21,85	-	-	127,40	500	2.000	8.000
	4,8 x 16	5/8	23,90	35,85	-	137,80	250	2.000	8.000
	4,8 x 19	3/4	26,50	39,75	-	141,90	250	2.000	8.000
	4,8 x 22	7/8	30,90	-	-	-	250	2.000	8.000
	4,8 x 25	1	32,35	48,55	85,65	152,20	250	1.000	4.000
	4,8 x 32	1-1/4	36,75	55,15	90,30	213,25	250	1.000	4.000
	4,8 x 38	1-1/2	41,20	61,80	93,95	231,70	250	1.000	2.000
	4,8 x 45	1-3/4	47,05	70,60	-	-	250	1.000	2.000
	4,8 x 50	2	52,95	79,45	105,30	275,95	250	1.000	2.000
	4,8 x 63	2-1/2	70,25	-	-	327,25	250	1.000	2.000
4,8 x 75	3	85,30	-	-	374,00	100	400	800	
4,8 x 90	3-5/8	141,25	-	-	-	100	400	800	
4,8 x 100	4	159,10	-	-	-	100	400	800	
4,8 x 110	4-3/8	180,00	-	-	-	100	400	800	
4,8 x 120	4-3/4	210,00	-	-	-	100	400	800	
Ø 5,5 (Nº12)	5,5 x 19	3/4	39,25	-	-	-	250	1.000	4.000
	5,5 x 25	1	42,45	-	-	-	250	1.000	4.000
	5,5 x 32	1-1/4	49,85	-	-	-	250	1.000	4.000
	5,5 x 38	1-1/2	58,35	-	-	-	250	1.000	2.000
	5,5 x 50	2	99,75	-	-	-	250	1.000	2.000
	5,5 x 63	2-1/2	113,50	-	-	-	100	400	800
5,5 x 75	3	137,90	-	-	-	100	400	800	

* Hasta agotar existencias.

* Fin serie.

* End of stock.

¹ La punta broca en inoxidable puede taladrar aluminio pero no es adecuada para taladrar hierro o acero.

¹ La pointe de la vis autoperceuse en inox peut percer l'aluminium mais ne peut pas percer des pièces en fer ou en acier.

¹ The stainless self drilling point can drill aluminium but it isn't hard enough to drill on steel.

Tornillos Autotaladrantes para Chapa / Vis Autoperceuses / Selfdrilling Screws

DIN 7504-N Lacado / Laquée / Lackered

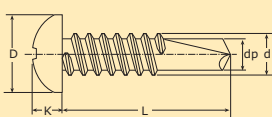

- Cabeza Alomada
- Philips (H)

- Tête Cylindrique Bombée
- Philips (H)

- Pan Head
- Philips (H)

Ø	3,5	4,2
D	6,9	8,2
K	2,6	3,05
dp Max	2,8	3,6
	H2	H2

Medidas en mm / Mesures en mm / Measures in mm

Diámetro Diamètre Diameter			Precios / Prix / Prices (€/1000 u.)					Envasado / Conditionnement / Packing		
			Rojo Burdeos Rouge Red	Verde Musgo Vert Green	Marfil Beige Cream	Blanco Blanc White	Verde Oliva Zingué Vert Green Zinc Plated	Caja Retail Box	Retractable Plastic Pack	Embalaje Pack Box
			Caja / Carton Box	Caja / Carton Box	Caja / Carton Box	Caja / Carton Box	Caja / Carton Box	pcs	pcs	pcs
Ø 3,5 (N°6)	3,5 x 9,5	3/8	-	-	-	27,00	17,85	1.000	8.000	32.000
	3,5 x 13	1/2	51,50	51,50	51,50	-	-	500	4.000	16.000
Ø 4,2 (N°8)	4,2 x 13	1/2	59,65	59,65*	59,65*	-	-	500	4.000	16.000
	4,2 x 16	5/8	61,10*	61,10*	61,10*	-	-	500	2.000	8.000
	4,2 x 19	3/4	62,75*	62,75*	62,75*	-	-	500	2.000	8.000

* Hasta agotar existencias. * Fin serie. * End of stock.

Otros colores y dimensiones bajo demanda / Autres Couleurs et Dimensions à la Demande / Other Colours and Dimensions upon Request

- Azul / BLEU / BLU: Ral 5009
- Crema Bidasoa / Crème / Cream: Ral 1000
- Negro / Noir / Black: Ral 9005
- Rojo Teja / Rouge / Red: Ral 3011
- Rojo Coral / Rouge Corail / Coral Red: Ral 3003
- Cobre / Cuivre / Brass: Ral 8112

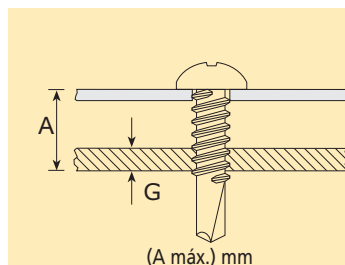

L (mm)	Ø 3,5	Ø 4,2	Ø 4,8	Ø 5,5	Ø 6,3
9,5	3	-	-	-	-
13	7	6	4	-	-
16	10	9	7	-	-
19	13	12	10	8	7
22	16	15	13	11	10
25	19	18	16	14	13
32	-	25	23	21	20
38	-	31	29	27	26
45	-	-	36	34	33
50	-	-	41	39	38
G Máx (mm)	2	3	4	5	6

Medidas en mm / Mesures en mm / Measures in mm

Refs. TN 42 / TN / TN55

Tapón embellecedor / Cache en plastique / Plastic cap



Diámetro Diamètre Diameter	Precios / Prix / Prices (€/1000 u.)			Envasado / Conditionnement / Packing		
	Blanco Blanc White	Negro Noir Black	Gris Gris Grey	Caja Retail Box	Retractable Plastic Pack	Embalaje Pack Box
	pcs	pcs	pcs	pcs	pcs	pcs
Ø4,2	29,80	29,80	-	1.000	4.000	8.000
Ø4,8	29,80	29,80	29,80	1.000	4.000	8.000
Ø5,5	29,80	29,80	-	1.000	4.000	8.000

Tornillos Autotaladrantes para Chapa / Vis Autoperceuses / Selfdrilling Screws

Ref. A-85 T

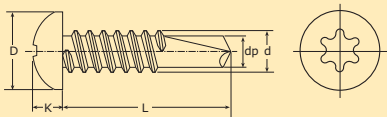

• Cabeza Alomada

• **TORX**

• Punta Broca

• Tête Cylindrique Bombée

• **TORX**

• Autoperceuse

• Pan Head

• **TORX**

• Selfdrilling Screw

Ø	3,5	4,2	4,8
D	6,9	8,2	9,5
K	2,6	3,05	3,7
	T15	T20	T25

Medidas en mm / Mesures en mm / Measures in mm

			Precios / Prix / Prices (€/1000 u.)	Envasado / Conditionnement / Packing		
Diámetro Diamètre Diameter			Cincado Zingué Blanc Zinc Plated	Caja Retail Box	Retractil Plastic Pack	Embalaje Pack Box
				pcs	pcs	pcs
Ø 3,5 (Nº6)	3,5 x 16	5/8	15,75*	500	4.000	16.000
Ø 4,2 (Nº8)	4,2 x 13	1/2	19,10*	500	4.000	16.000
	4,2 x 19	3/4	21,35*	500	2.000	8.000
Ø 4,8 (Nº10)	4,8 x 50	2	61,45*	250	1.000	2.000

* Hasta agotar existencias. * Fin serie. * End of stock.

- Los tornillos autotaladrantes con mortaja **TORX** quedan sustituidos por impronta **sit**. Ref. A85S.
- Les vis autoperceuses avec empreinte **TORX** sont remplacés par la même vis avec empreinte **sit**. Ref. A85S.
- Selfdrilling screws with **TORX** recess will be replaced by the same screws with **sit** recess Ref. A85S.

Ref. A-85 TI

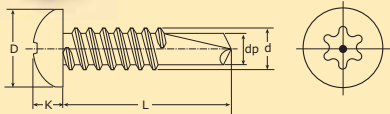

• **TORX** Inviolable

• Punta Broca

• **TORX** Inviolable

• Autoperceuse

• Tamper Proof **TORX**

• Selfdrilling Screw

Ø	3,9
D	7,5
K	2,8
	T20

Medidas en mm / Mesures en mm / Measures in mm

			Precios / Prix / Prices (€/1000 u.)	Envasado / Conditionnement / Packing		
Diámetro Diamètre Diameter			Cincado Zingué Blanc Zinc Plated	Caja Retail Box	Retractil Plastic Pack	Embalaje Pack Box
				pcs	pcs	pcs
Ø 3,9 (Nº7)	3,9 x 13	3/8	45,25	500	4.000	16.000

Tornillos Autotaladrantes para Chapa / Vis Autoperceuses / Selfdrilling Screws

Ref. A 85 S

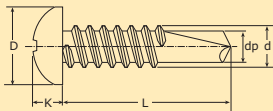

• Cabeza Alomada

• **sit**

• Punta Broca

• Tête Cylindrique Bombée

• **sit**

• Autoperceuse

• Pan Head

• **sit**

• Selfdrilling Screw

Ø	3,5 ¹	4,2	4,8	5,5
D	7	8	9,5	11
K	2,8	3,1	3,7	4
	SIT20	SIT20	SIT25	SIT25

¹ INOX 3,5 SIT 10. Medidas en mm / Mesures en mm / Measures in mm

EL TORNILLO SE AGUANTA EN LA PUNTA DEL ATORNILLADOR
LA VIS RESTE COLLÉE À L'EMBOUT DE VISSAGE SIT®
THE SCREW STICKS ON THE SIT® BITS



MEJOR TRANSMISIÓN DEL PAR DE APRIETE
AMÉLIORATION DE LA TRANSMISSION DU COUPLE DE VISSAGE
MORE EFFICIENT TORQUE TRANSFER

			Precios / Prix / Prices (€/1000 u.)		Envasado / Conditionnement / Packing		
Diámetro Diamètre Diameter			Cincado Zingué Blanc Zinc Plated	Inox. A2 Inox. A2 Stainless steel A2	Caja Retail Box	Retractil Plastic Pack	Embalaje Pack Box
					pcs	pcs	pcs
Ø 3,5 (N°6)	3,5 x 9,5	3/8	16,95	86,90	1.000	8.000	32.000
	3,5 x 13	1/2	19,60	101,35	500	4.000	16.000
	3,5 x 16	5/8	22,25	115,90	500	4.000	16.000
	3,5 x 19	3/4	24,85	-	500	2.000	8.000
	3,5 x 25	1	32,70	-	250	2.000	8.000
Ø 4,2 (N°8)	4,2 x 13	1/2	26,20	137,55	500	4.000	16.000
	4,2 x 16	5/8	27,50	130,35	500	2.000	8.000
	4,2 x 19	3/4	31,40	137,55	500	2.000	8.000
	4,2 x 25	1	39,25	166,55	250	2.000	8.000
	4,2 x 32	1-1/4	47,10	-	250	1.000	4.000
	4,2 x 38	1-1/2	53,65	-	250	1.000	4.000
	4,2 x 50	2	66,75	-	250	1.000	2.000
Ø 4,8 (N°10)	4,8 x 13	1/2	36,60	181,00	250	2.000	8.000
	4,8 x 16	5/8	39,25	195,55	250	2.000	8.000
	4,8 x 19	3/4	44,45	210,00	250	2.000	8.000
	4,8 x 25	1	53,65	224,45	250	1.000	4.000
	4,8 x 32	1-1/4	62,80	253,45	250	1.000	4.000
	4,8 x 38	1-1/2	69,40	282,45	250	1.000	2.000
	4,8 x 45	1-3/4	71,95	-	250	1.000	2.000
	4,8 x 50	2	77,15	325,90	250	1.000	2.000
	4,8 x 63	2-3/8	92,90	369,25	250	1.000	2.000
	4,8 x 75	2-3/4	128,25	427,20	100	400	800
	4,8 x 90	3-5/8	196,30	-	100	400	800
Ø 5,5 (N°12)	5,5 x 19	3/4	58,85	-	250	1.000	4.000
	5,5 x 25	1	64,05	-	250	1.000	4.000
	5,5 x 32	1-1/4	71,95	-	250	1.000	4.000
	5,5 x 38	1-1/2	85,00	-	250	1.000	2.000
	5,5 x 50	2	143,85	-	250	1.000	2.000
	5,5 x 63	2-3/8	170,05	-	100	400	800
	5,5 x 75	2-3/4	196,30	-	100	400	800

¹ La punta broca en inoxidable puede taladrar aluminio pero no es adecuada para taladrar hierro o acero.

Tornillos Autotaladrantes para Chapa / Vis Autoperceuses / Selfdrilling Screws

Ref. A 61 S

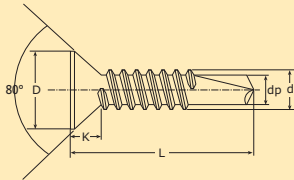

- Cabeza Avellanada
- **sit.**
- Punta Broca

- Tête Fraisée
- **sit.**
- Autoperceuse

- Countersunk Head
- **sit.**
- Selfdrilling

Ø	3,5	3,9	4,2	4,8
D	7	7,5	8	9
K	3,1	3,2	3,6	3,9
	SIT10	SIT20	SIT20	SIT20

Medidas en mm / Mesures en mm / Measures in mm

			Precios / Prix / Prices (€/1000 u.)	Envasado / Conditionnement / Packing		
Diámetro Diamètre Diameter			Cincado	Caja Retail Box	Retractable Plastic Pack	Embalaje Pack Box
				pcs	pcs	pcs
Ø 3,5 (Nº6)	3,5 x 13	1/2	23,60	500	4.000	16.000
	3,5 x 16	5/8	24,85	500	4.000	16.000
	3,5 x 19	3/4	26,20	500	4.000	16.000
Ø 3,9 (Nº7)	3,9 x 13	1/2	27,50	500	4.000	16.000
	3,9 x 16	5/8	30,15	500	4.000	16.000
	3,9 x 19	3/4	37,90	500	2.000	8.000
Ø 4,2 (Nº8)	4,2 x 13	1/2	27,50	500	4.000	16.000
	4,2 x 16	5/8	30,15	500	2.000	8.000
	4,2 x 19	3/4	36,50	500	2.000	8.000
	4,2 x 25	1	40,60	250	2.000	8.000
	4,2 x 32	1-1/4	47,10	250	1.000	4.000
Ø 4,8 (Nº10)	4,8 x 19	3/4	48,40	250	2.000	8.000
	4,8 x 25	1	60,20	250	1.000	4.000
	4,8 x 32	1-1/4	65,45	250	1.000	4.000
	4,8 x 38	1-1/2	79,85	250	1.000	2.000
	4,8 x 50	2	85,00	250	1.000	2.000



**Solicite nuestro
catálogo especializado
Demandez notre
catalogue technique
As for our technical
catalogue**

Tornillos Autotaladrantes para Chapa / Vis Autoperceuses / Selfdrilling Screws

DIN 7504-P

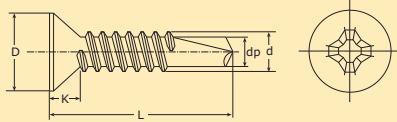

- Cabeza Avellanada
- Tête Fraisée
- Countersunk Head
- Philips (H)
- Philips (H)
- Selfdrilling Screw
- Punta Broca
- Autoperceuse

Ø	3,5	3,9	4,2	4,8	5,5
D	6,9	7,5	8,2	9,5	10,8
K	2,6	2,3	3,05	3,55	3,95
dp Max	2,8	3,2	3,6	4,1	4,8
	H2	H2	H2	H2	H3

Medidas en mm / Mesures en mm / Measures in mm

			Precios / Prix / Prices (€/1000 u.)			Envasado / Conditionnement / Packing		
Diámetro Diamètre Diameter			Cincado Zingué Blanc Zinc Plated	Cincado Negro Zingué Noir Black Zinc Plated	Inox. A2 ¹ Inox. A2 ¹ Stainless steel A2 ¹	Caja Retail Box	Retractable Plastic Pack	Embalaje Pack Box
			Caja / Carton Box	Bolsa / Sachtet Bag	Caja / Carton Box	pcs	pcs	pcs
Ø 3,5 (Nº 6)	3,5 x 13	1/2	11,65	17,50	85,55	500	4.000	16.000
	3,5 x 16	5/8	12,40	18,60	88,10	500	4.000	16.000
	3,5 x 19	3/4	13,85	20,80	-	500	4.000	16.000
	3,5 x 25	1	17,80	26,70	-	250	2.000	8.000
Ø 3,9 (Nº 7)	3,9 x 13	1/2	15,30	-	-	500	4.000	16.000
	3,9 x 16	5/8	16,80	-	-	500	4.000	16.000
	3,9 x 19	3/4	20,50	-	-	500	2.000	8.000
	3,9 x 25	1	23,35	-	-	250	2.000	8.000
	3,9 x 32	1-1/4	25,60	-	-	250	2.000	8.000
Ø 4,2 (Nº 8)	3,9 x 38	1-1/2	27,05	-	-	250	1.000	4.000
	4,2 x 13	1/2	15,30	22,95	-	500	4.000	16.000
	4,2 x 16	5/8	16,80	25,20	-	500	2.000	8.000
	4,2 x 19	3/4	19,40	29,10	-	500	2.000	8.000
	4,2 x 25	1	21,95	32,95	-	250	2.000	8.000
Ø 4,8 (Nº 10)	4,2 x 32	1-1/4	25,60	38,15	-	250	1.000	4.000
	4,8 x 13	1/2	23,35	-	-	500	2.000	8.000
	4,8 x 16	5/8	23,35	-	-	250	2.000	8.000
	4,8 x 19	3/4	25,60	-	-	250	2.000	8.000
	4,8 x 25	1	32,90	49,35	-	250	1.000	4.000
	4,8 x 32	1-1/4	37,30	-	-	250	1.000	4.000
Ø 5,5 (Nº 12)	4,8 x 38	1-1/2	43,25	-	-	250	1.000	2.000
	4,8 x 50	2	51,35	-	-	250	1.000	2.000
	5,5 x 32	1-1/4	55,65	-	-	250	1.000	4.000
	5,5 x 38	1-1/2	58,95	-	-	250	1.000	2.000
	5,5 x 50	2	109,90	-	-	250	1.000	2.000

¹ La punta broca en inoxidable puede taladrar aluminio pero no es adecuada para taladrar hierro o acero.

¹ La pointe de la vis autoperceuse en inox peut percer l'aluminium mais ne peut pas percer des pièces en fer ou en acier.

¹ The stainless self drilling point can drill aluminium but it isn't hard enough to drill on steel.

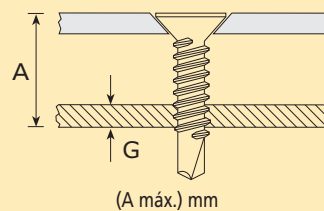

L (mm)	Ø 3,5	Ø 3,9	Ø 4,2	Ø 4,8	Ø 5,5	Ø 6,3
13	7	7	6	5	-	-
16	10	10	9	8	-	-
19	13	13	12	11	9	8
25	19	19	18	17	15	14
32	-	26	25	24	22	21
38	-	32	31	30	28	27
50	-	-	-	42	38	37
G Máx. (mm)	2	2	3	4	5	6

Medidas en mm / Mesures en mm / Measures in mm

Tornillos Autotaladrantes para Chapa / Vis Autoperceuses / Selfdrilling Screws

DIN 7504-K



- Cabeza Hexagonal+Arandela
- Punta Broca

- Tête Hexagonale+Embase
- Autoperceuse

- Hexagonal Head+Washer
- Selfdrilling Screw

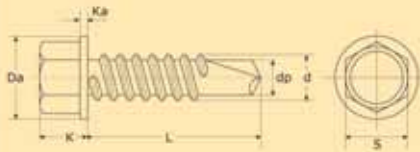

Ø	3,5	4,2	4,8	5,5	6,3
D	5,5	7	8	8	10
K	3,45	4,25	4,45	5,45	6,45
Da Max.	8,3	8,8	10,5	11	13,2
Ka Min.	0,6	0,9	0,9	1,0	1,0
dp. Max	2,8	3,6	4,1	4,8	5,8
	V5,5	V7	V8	V8	V10

Medidas en mm / Mesures en mm / Measures in mm

Láminas de Zinc Aluminio Gris:

- Soporta una resistencia a la corrosión de 480 HNS (seis veces superior a un cincado).
- Exento de cromo y metales pesados, cumple con la normativa RoHS.

Lames de Zinc Aluminium Gris:

- Tenue à la corrosion de 480 HSS (6 fois supérieure au zingué normal)
- Sans Cr6+, selon RoHS.

Grey Zinc Aluminium flake coating:

- Corrosion resistance 480 HSS (6 times higher than normal zincplated)
- RoHS compliant

Datos			Precios / Prix / Prices (€/1000 u.)		Envasado / Conditionnement / Packing		
Diámetro Diamètre Diameter			Cincado Zingué Blanc Zinc Plated	Lam. Zn-Al ¹ Lam. Zn-Al ² Zn-Al Flake ³	Caja Retail Box	Retractil Plastic Pack	Embalaje Pack Box
					pcs	pcs	pcs
Ø 3,5 (N° 6)	3,5 x 13	1/2	16,95	-	500	4.000	16.000
	3,5 x 16	5/8	18,80	-	500	2.000	8.000
	3,5 x 19	3/4	20,00	-	500	2.000	8.000
Ø 4,2 (N° 8)	4,2 x 13	1/2	21,20	-	500	2.000	8.000
	4,2 x 16	5/8	23,10	-	500	2.000	8.000
	4,2 x 19	3/4	28,55	-	500	2.000	8.000
	4,2 x 25	1	30,90	-	250	1.000	4.000
Ø 4,8 (N° 10)	4,8 x 13	1/2	29,70	-	250	2.000	8.000
	4,8 x 16	5/8	29,70	42,90	250	2.000	8.000
	4,8 x 19	3/4	29,70	42,90	250	1.000	4.000
	4,8 x 25	1	38,95	-	250	1.000	4.000
	4,8 x 32	1-1/4	42,45	-	250	1.000	4.000
	4,8 x 38	1-1/2	50,15	-	250	1.000	2.000
	4,8 x 50	2	61,70	-	250	1.000	2.000
Ø 5,5 (N° 12)	5,5 x 19	3/4	34,10	-	500	1.000	4.000
	5,5 x 22	7/8	39,25	56,10	500	1.000	4.000
	5,5 x 32	1-1/4	57,85	83,60	500	1.000	4.000
	5,5 x 38	1-1/2	64,80	-	250	1.000	2.000
	5,5 x 45	1-3/4	76,35	-	250	1.000	2.000
	5,5 x 50	2	79,50	-	250	1.000	2.000
Ø 6,3 (N° 14)	5,5 x 63	2-1/2	92,55	-	100	400	800
	6,3 x 19	3/4	62,50	-	250	1.000	4.000
	6,3 x 25	1	67,15	96,80	500	1.000	2.000
	6,3 x 32	1-1/4	81,00	116,60	500	1.000	2.000
	6,3 x 38	1-1/2	88,65	127,60	500	1.000	2.000
	6,3 x 45	1-3/4	111,80	-	100	400	800
	6,3 x 50	2	111,80	160,60	200	400	800
6,3 x 63	2-1/2	131,20	-	100	400	800	



Tornillos para Carpintería de Aluminio / Vis pour profiles en Aluminium / Screws for aluminium profiles

Ref. BTT

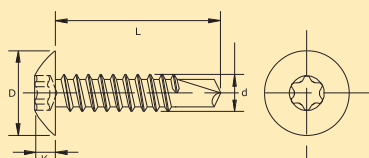

- Cabeza Redonda **sit**
- Punta Broca

- Tête Ronde **sit**
- Autoperceuse

- Round Head **sit**
- Selfdrilling Point



Aplicaciones:

- Para fijación de chapas de acero en construcciones exteriores metálicas, tipo marquesinas, fachadas, etc.

Ventajas:

- Estética exterior más atractiva.
- Cabeza ancha para agujeros sobredimensionados.
- Mortaja **sit** que asegura un ajuste perfecto con la punta facilitando la instalación.

Applications:

- Pour fixation de tôles en acier sur les façades des bâtiments.

Avantages:

- Amélioration de la sthétique grâce à la géométrie de la tête ronde.
- Grand diamètre de tête pour trous surdimensionnés.
- Empreinte **sit** pour améliorer la fixation.

Applications:

- To assemble metal sheets or panels. Mainly used in cladding.

Advantages:

- Truss head design Improves aesthetics.
- Larger head diameter for oversized holes.
- **sit** recess ensures a good stick fit.

			Precios / Prix / Prices (€/1000 u.)			Envasado / Conditionnement / Packing		
Diámetro Diamètre Diameter			Cincado	Lám. Zn-Al ¹	Inox. A2 ²	Caja Retail Box	Retractil Plastic Pack	Embalaje Pack Box
			Zingué Blanc Zinc Plated	Lám. Zn-Al ¹ Zn-Al Flake ¹	Inox. A2 ² Stainless steel A2 ²			
Ø 4,2 (N°8)	4,2 x 13	1/2	34,25	-	-	500	2.000	8.000
	4,2 x 16	5/8	36,75	-	-	500	2.000	8.000
	4,2 x 19	3/4	39,15	-	-	250	2.000	8.000
	4,2 x 25	1	48,95	-	-	250	1.000	4.000
Ø 4,8 (N°12)	4,8 x 19	3/4	57,20	143,00	-	500	1.000	4.000
	4,8 x 25	1	62,90	171,60	429,00	500	1.000	4.000

¹ Láminas Zinc Aluminio 480 HNS ver pág. 50 de información técnica.

¹ Lames de Zinc Aluminium, 480 HSS voire page 50.

¹ Zinc Aluminium Flake system, 480 HSS see page 50.

² Para perfil de aluminio.

² Pour profilés en aluminium

² For aluminium profiles.



Ref. BTN

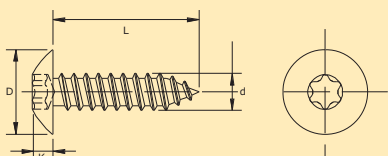

- Cabeza Boton **sit**
- Punta Forma C

- Tête Ronde **sit**
- Pointe C

- Head Round **sit**
- C Point

Ø	3,9	4,2	4,8
D	10	11	12
K	2,4	2,6	3,1
	SIT20	SIT20	SIT20

Medidas en mm / Mesures en mm / Mesures in mm

			Precios / Prix / Prices (€/1000 u.)			Envasado / Conditionnement / Packing		
Diámetro Diamètre Diameter			Cincado	Lám. Zn-Al ¹	Inox. A2 ²	Caja Retail Box	Retractil Plastic Pack	Embalaje Pack Box
			Zingué Blanc Zinc Plated	Lám. Zn-Al ¹ Zn-Al Flake ¹	Inox. A2 ² Stainless steel A2 ²			
Ø 3,9 (N°7)	3,9 x 13	1/2	29,35	-	-	500	2.000	8.000
	3,9 x 16	5/8	31,85	-	-	500	2.000	8.000
Ø 4,2 (N°8)	4,2 x 13	3/4	31,85	-	-	500	2.000	8.000
	4,2 x 16	5/8	34,25	-	-	500	2.000	8.000
Ø 4,8 (N°12)	4,8 x 13	1/2	40,45	-	-	500	2.000	8.000
	4,8 x 16	5/8	45,30	-	-	250	1.000	4.000
	4,8 x 19	3/4	52,65	-	-	250	1.000	4.000

Tornillos para Chapa / Vis à Tôle / Selftapping Screws

DIN 7971



• Cabeza Alomada

• Ranurado

• Punta Forma C

• Tête Cylindrique Bombée

• Fendue

• Pointe C

• Pan Head

• Slotted

• C Point

			Precios / Prix / Prices (€/1000 u.)			Envasado / Conditionnement / Packing			
Diámetro Diamètre Diameter			Cincado Zingué Blanc Zinc Plated	Cincado Zingué Blanc Zinc Plated	Inox. A2 Inox. A2 Stainless steel A2	Caja Retail Box	Retractable Plastic Pack	Embalaje Pack Box	Bolsa Sachet Bag
			Caja / Carton Box	Bolsa / Sachet Bag	Caja / Carton Box	pcs	pcs	pcs	pcs
Ø 2,2 (Nº 2)	2,2 x 5	-	-	21,25*	-	-	-	-	5.000
	2,2 x 6,5	1/4	21,05	-	-	1.000	8.000	32.000	-
	2,2 x 9,5	3/8	22,10*	-	-	1.000	8.000	32.000	5.000
	2,2 x 13	1/2	23,30	-	-	1.000	8.000	32.000	-
	2,2 x 16	5/8	24,00*	-	-	1.000	8.000	32.000	-
Ø 2,9 (Nº 4)	2,9 x 5	-	-	18,20*	-	-	-	-	5.000
	2,9 x 6,5	1/4	15,20	14,75	-	1.000	8.000	32.000	5.000
	2,9 x 8	-	-	14,10	-	-	-	-	5.000
	2,9 x 9,5	3/8	14,65	-	-	1.000	8.000	32.000	-
	2,9 x 13	1/2	16,55	15,95	-	1.000	8.000	32.000	5.000
	2,9 x 16	5/8	18,30*	17,70	-	1.000	4.000	16.000	5.000
	2,9 x 19	3/4	20,80*	-	-	1.000	4.000	16.000	-
	2,9 x 25	1	26,80*	-	-	500	2.000	8.000	-
Ø 3,3 (Nº 5)	3,3 x 6,5	1/4	18,00*	-	-	1.000	8.000	32.000	-
	3,3 x 13	1/2	20,80*	-	-	500	4.000	16.000	-
	3,3 x 25	1	29,20	-	-	500	2.000	8.000	-
Ø 3,5 (Nº 6)	3,5 x 9,5	3/8	16,80	14,10	48,05*	1.000	8.000	32.000	5.000
	3,5 x 13	1/2	19,65	-	-	500	4.000	16.000	-
	3,5 x 16	5/8	20,80	21,00	52,70*	500	4.000	16.000	2.500
	3,5 x 19	3/4	25,10*	-	59,55*	500	2.000	8.000	-
	3,5 x 25	1	32,25	-	77,30	250	2.000	8.000	-
	3,5 x 32	1-1/4	37,10*	-	-	250	2.000	8.000	-
Ø 3,9 (Nº 7)	3,9 x 6,5	1/4	21,45*	-	-	500	4.000	16.000	-
	3,9 x 9,5	3/8	21,45	20,55	-	500	4.000	16.000	2.500
	3,9 x 13	1/2	22,25	-	63,00*	500	4.000	16.000	-
	3,9 x 16	5/8	25,10	24,15	57,25*	500	2.000	8.000	2.500
	3,9 x 19	3/4	28,55	-	-	500	2.000	8.000	-
	3,9 x 25	1	34,80*	-	-	250	2.000	8.000	-
	3,9 x 32	1-1/4	41,45	40,10	-	250	1.000	4.000	1.000

* Hasta agotar existencias. * Fin serie. * End of stock.

Tornillos para Chapa / Vis à Tôle / Selftapping Screws

DIN 7971

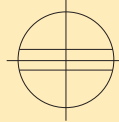
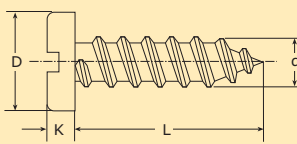

Diámetro	2,2	2,9	3,3	3,5	3,9	4,2	4,8	5,5	6,3
D	4,2	5,6	6,2	6,9	7,5	8,2	9,5	10,8	12,5
K	1,35	1,75	2	2,1	2,25	2,45	2,8	3,2	3,6
Punta Atorn.	P2	P3	P35	P35	P4	P4	P5	P6	P6



			Precios / Prix / Prices (€/1000 u.)					Envasado / Conditionnement / Packing			
Diámetro Diamètre Diameter			Cincado Zingué Blanc Zinc Plated	Cincado CR III Zingué CR III Zinc CR III	Cincado Negro ¹ Zingué noir ¹ Black Zinc Plated ¹	Lacado Blanco Laquée Blanc White Lackered	Inox. A2 Inox. A2 Stainless steel A2	Caja Retail Box	Retractil Plastic Pack	Embalaje Pack Box	Bolsa Sachet Bag
			Caja / Carton Box	Bolsa / Sachet Bag	Caja / Carton Box	Caja / Carton Box	Caja	pcs	pcs	pcs	pcs
Ø 4,2 (N°8)	4,2 x 6,5	1/4	23,45*	-	-	-	-	500	4.000	16.000	-
	4,2 x 9,5	3/8	23,45	-	-	-	-	500	4.000	16.000	-
	4,2 x 13	1/2	22,70	22,30	-	-	66,60*	500	4.000	16.000	2.500
	4,2 x 16	5/8	27,45	-	-	-	-	500	2.000	8.000	-
	4,2 x 19	3/4	29,90	-	-	-	78,80*	500	2.000	8.000	-
	4,2 x 22	7/8	34,15*	-	-	101,20*	89,05*	250	2.000	8.000	-
	4,2 x 25	1	34,70	-	52,05*	106,25*	-	250	2.000	8.000	-
	4,2 x 32	1-1/4	46,95	-	-	-	105,90*	250	1.000	4.000	-
	4,2 x 38	1-1/2	53,70	-	-	-	122,80*	250	1.000	4.000	-
	4,2 x 45	1-3/4	65,30*	-	-	-	184,70*	250	1.000	4.000	-
4,2 x 50	2	-	-	-	195,00*	184,70*	250	1.000	4.000	-	
4,2 x 70	2-3/4	117,05*	-	-	-	-	250	1.000	2.000	-	
Ø 4,8 (N°10)	4,8 x 9,5	3/8	34,15	-	-	-	-	500	2.000	8.000	-
	4,8 x 13	1/2	34,15	-	-	-	87,05*	500	2.000	8.000	-
	4,8 x 16	5/8	37,85	-	-	-	94,70*	250	2.000	8.000	-
	4,8 x 19	3/4	42,80	-	-	-	98,75*	250	2.000	8.000	-
	4,8 x 22	7/8	46,30	-	-	-	-	250	2.000	8.000	-
	4,8 x 25	1	46,30	-	-	-	114,55*	250	1.000	4.000	-
	4,8 x 32	1-1/4	57,90	-	-	-	128,85*	250	1.000	4.000	-
	4,8 x 38	1-1/2	65,85	-	-	-	158,15*	250	1.000	2.000	-
	4,8 x 45	1-3/4	84,80*	-	-	-	209,20*	250	1.000	2.000	-
	4,8 x 50	2	96,95	-	-	186,65*	213,90*	250	1.000	2.000	-
4,8 x 60	2-3/8	120,10	-	-	-	267,10*	250	1.000	2.000	-	
4,8 x 70	2-3/4	136,30*	-	-	-	280,90*	100	400	800	-	
Ø 5,5 (N°12)	5,5 x 13	1/2	45,75*	-	-	-	103,85*	250	2.000	8.000	-
	5,5 x 16	5/8	48,70*	-	-	-	145,30*	250	2.000	8.000	-
	5,5 x 19	3/8	53,05*	-	-	-	167,95*	250	1.000	4.000	-
	5,5 x 22	7/8	59,70*	-	-	-	-	250	1.000	4.000	-
	5,5 x 25	1	59,70	-	88,00*	145,65*	188,75*	250	1.000	4.000	-
	5,5 x 32	1-1/4	80,50*	-	120,75*	-	221,55*	250	1.000	4.000	-
	5,5 x 38	1-1/2	85,90*	-	-	178,65*	241,50*	250	1.000	2.000	-
	5,5 x 45	1-3/4	99,45*	-	-	-	-	250	1.000	2.000	-
	5,5 x 50	2	110,30	-	-	-	291,15*	250	1.000	2.000	-
	5,5 x 60	2-3/8	158,00*	-	-	-	-	100	400	800	-
5,5 x 70	2-3/4	179,20	-	-	-	341,75*	100	400	800	-	
Ø 6,3 (N°14)	6,3 x 16	5/8	62,30*	-	-	-	-	250	1.000	4.000	-
	6,3 x 25	1	92,10*	-	-	-	-	250	1.000	4.000	-
	6,3 x 32	1-1/4	115,20*	-	-	-	-	250	1.000	2.000	-
	6,3 x 38	1-1/2	127,50*	-	-	-	-	250	1.000	2.000	-
	6,3 x 45	1-3/4	166,75*	-	-	-	-	250	1.000	2.000	-
6,3 x 50	2	173,20	-	-	-	-	250	-	-	-	



* Hasta agotar existencias. * Fin serie. * End of stock.

Tornillos para Chapa / Vis à Tôle / Selftapping Screws

DIN 7971 F

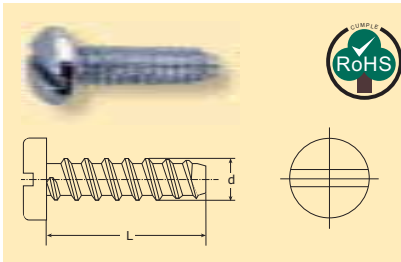

• Punta F (Bz)

Ø	2,2	2,9	3,5
D	4,2	5,6	6,9
K	1,8	2,2	2,6
	P2	P3	P35

• Pointe F (Bz)

• F Point (Bz)

Medidas en mm / Mesures en mm / Measures in mm

			Precios / Prix / Prices (€/1000 u.)		Envasado / Conditionnement / Packing	
Diámetro Diamètre Diameter			Cincado Zingué Blanc Zinc Plated		Bolsa Sachet Bag	
					pcs	
Ø 2,9 (N°4)	2,9 x 6,5	1/4	20,45*		5.000	
	2,9 x 8	-	21,25		5.000	
	2,9 x 13	1/2	22,10		5.000	
	2,9 x 25	1	36,05*		2.500	
Ø 3,5 (N°6)	3,5 x 9,5	3/8	21,10*		5.000	

* Hasta agotar existencias. * Fin serie. * End of stock.

DIN 7973

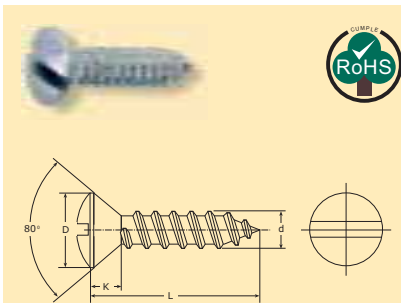

• Cabeza Gota Sebo

• Ranurado

• Punta Forma C

• Tête Fraisée Bombée

• Fendue

• Pointe Ce

• Countersunk Raised Head

• Slotted

• C Point

Ø	2,9	3,5	3,9	4,2	4,8
D	5,5	6,9	7,5	8,1	9,5
K	1,7	2,1	2,3	2,5	3,0
	P3	P35	P4	P4	P5

Medidas en mm / Mesures en mm / Measures in mm

			Precios / Prix / Prices (€/1000 u.)		Envasado / Conditionnement / Packing			
Diámetro Diamètre Diameter			Cincado Zingué Blanc Zinc Plated	Cincado	Caja Retail Box	Retractil Plastic Pack	Embalaje Pack Box	Bolsa Sachet Bag
			Caja / Carton Box	Bolsa Sachet / Bag	pcs	pcs	pcs	pcs
Ø 2,9 (N°4)	2,9 x 13	1/2	18,00*	-	1.000	8.000	32.000	-
Ø 3,5 (N°6)	3,5 x 16	5/8	22,50*	-	500	4.000	16.000	-
Ø 3,9 (N°7)	3,9 x 16	5/8	-	24,70*	-	-	-	2.500
Ø 4,2 (N°8)	4,2 x 19	3/4	32,45*	-	500	2.000	8.000	-
	4,2 x 25	1	37,70*	-	250	2.000	8.000	-
Ø 4,8 (N°10)	4,8 x 19	3/4	46,50*	-	250	2.000	8.000	-

* Hasta agotar existencias. * Fin serie. * End of stock.

DIN 7976

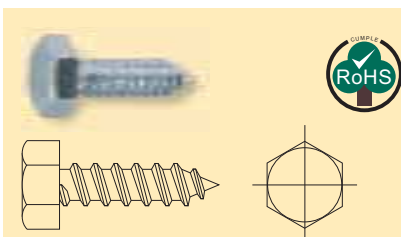

• Cabeza Hexagonal

• Punta Forma C

NOTA:

- Este tornillo se suministra sólo bajo encargo.

• Tête Hexagonale

• Pointe C

NOTE:

- Cette vis n'est pas standard et sera fabriquée à la commande.

• Hexagonal Head

• C Point

NOTE:

- This screw is only delivered upon special request.

Tornillos para Chapa / Vis à Tôle / Selftapping Screws

DIN 7972



- Cabeza Avellanada
- Tête Fraisée
- Countersunk Head
- Ranurado
- Fendue
- Slotted
- Punta Forma C
- Punta Forma C
- C Point

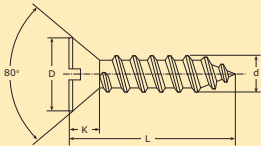

Ø	2,9	3,3	3,5	3,9	4,2	4,8	5,5
D	5,5	6,1	6,8	7,5	8,1	9,5	10,8
K	1,7	1,9	2,1	2,3	2,5	3	3,4
	P3	P35	P35	P4	P4	P5	P6

Medidas en mm / Mesures en mm / Measures in mm

			Precios / Prix / Prices (€/1000 u.)		Envasado / Conditionnement / Packing		
Diámetro Diamètre Diameter			Cincado Zingué Blanc Zinc Plated	Inox. A2 Inox. A2 Stainless steel A2	Caja Retail Box	Retractable Plastic Pack	Embalaje Pack Box
					pcs	pcs	pcs
Ø 2,9 (Nº4)	2,9 x 9,5	3/8	16,10	-	1.000	8.000	32.000
	2,9 x 13	1/2	18,20*	-	1.000	8.000	32.000
	2,9 x 25	1	-	61,05	500	2.000	8.000
Ø 3,5 (Nº6)	3,5 x 9,5	3/8	17,23*	-	1.000	8.000	32.000
	3,5 x 13	1/2	-	53,60*	500	4.000	16.000
	3,5 x 16	5/8	22,90*	54,65*	500	4.000	16.000
	3,5 x 19	3/4	27,60*	-	500	2.000	8.000
Ø 3,9 (Nº7)	3,9 x 22	7/8	37,70*	-	250	2.000	8.000
Ø 4,2 (Nº8)	4,2 x 9,5	3/8	25,00*	64,25*	500	4.000	16.000
	4,2 x 13	1/2	24,95*	69,05*	500	4.000	16.000
	4,2 x 16	5/8	30,20*	78,15*	500	2.000	8.000
	4,2 x 19	3/4	-	81,80*	500	2.000	8.000
	4,2 x 25	1	38,15*	97,75*	250	2.000	8.000
	4,2 x 32	1-1/4	51,65*	109,95*	250	1.000	4.000
	4,2 x 38	1-1/2	59,05*	127,35*	250	1.000	4.000
	4,2 x 45	1-3/4	-	183,50*	250	1.000	4.000
	4,2 x 50	2	88,20*	-	250	1.000	2.000
4,2 x 60	2-3/8	112,65*	-	250	1.000	2.000	
Ø 4,8 (Nº10)	4,8 x 13	1/4	-	90,25*	500	2.000	8.000
	4,8 x 19	3/4	46,90*	102,50*	250	2.000	8.000
	4,8 x 22	7/8	-	113,60*	250	2.000	8.000
	4,8 x 38	1-1/2	-	164,00*	250	1.000	2.000
	4,8 x 45	1-3/4	93,30*	-	250	1.000	2.000
Ø 5,5 (Nº12)	5,5 x 19	3/4	-	156,55*	250	1.000	4.000
	5,5 x 25	1	64,50*	195,95*	250	1.000	4.000
	5,5 x 70	2-3/4	197,10*	-	100	400	800

* Hasta agotar existencias. * Fin serie. * End of stock.

Tornillos para Carpintería de Aluminio / Vis pour profiles en Aluminium / Screws for aluminium profiles

Ref. CE PLUS

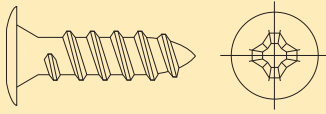
- Cabeza Extraplana
- Philips (H2)

- Tête Extra Plate
- Philips (H2)

- Screw Extra Low Head
- Philips (H2)



Ventajas:

- Cabeza extraplana y cantos biselados.
- Facilita, aun más, el paso de la corredera.
- Recomendado para todas aquellas aplicaciones donde la altura de la cabeza deba ser mínima. Por ejemplo en la fijación de cierres embutidos en ventanas correderas, fijaciones en el interior de vehículos, etc...

Ventajas:

- Tête extra plate.
- Plus performante pour les fenêtres coulissantes.
- Recommandée dans toutes les applications où la hauteur de la tête doit être minimum. Ex. poignées encastrées pour portes coulissantes, fixations dans les intérieurs de voitures, etc...

Ventajas:

- Extra low head.
- Very convenient for applications where the head height must be minimum.
- Allows the crossing of sliding windows. Ex. Sliding windows, automobile, etc...



PATENTADO
REGISTRÉ
PATENTED

		Precios / Prix / Prices (€/1000 u.)				Envasado / Conditionnement / Packing		
Diámetro Diamètre Diameter		Cincado Zingué Blanc Zinc Plated	Cincado Negro ¹ Zingué Noir ¹ Black Zinc Plated ¹	Lacado Blanco Laquée Blanc White Lackered	Inox. A2 Inox. A2 Stainless steel A2	Caja Retail Box	Retractil Plastic Pack	Embalaje Pack Box
		pcs	pcs	pcs	pcs	pcs	pcs	pcs
Ø 4,2	4,2x13	19,25	28,05	64,35	93,60	500	4.000	16.000
	4,2x22	26,95	39,70	79,15	130,80	250	2.000	8.000
	4,2x32	36,50	53,70	110,10	159,55	250	1.000	4.000



Ref. CET PLUS



- Cabeza Extraplana
- Philips (H2)
- Punta Broca Reducida

- Tête Extra Plate
- Philips (H2)
- Autoperceuse

- Selftapping Extra Low Head
- Philips (H2)
- Selfdrilling Screw

Ventajas:

- Mismo diseño y mismas aplicaciones que la Ref. CE, pero con punta autotaladrante reducida, especial para taladrar chapas de aluminio (hasta 2,5mm.), y chapas finas de acero (de 0,7 hasta 1,5mm.)

Ventajas:

- Même dessin et mêmes applications que la Ref. CE, mais avec une pointe autoperceuse réduite, spéciale pour percer les tôles en aluminium (jusqu'à 2,5mm), et des tôles fines en acier (de 0,7 à 2mm).

Ventajas:

- Same design and applications than Ref. CE, but with a reduced drill point. Special for aluminium sheet (up to 2,5mm) and thin metal sheets (0,7 to 2mm).

		Precios / Prix / Prices (€/1000 u.)					Envasado / Conditionnement / Packing		
Diámetro Diamètre Diameter		Cincado Zingué Blanc Zinc Plated	Cincado Negro Zingué Noir Black Zinc Plated	Lacado Blanco Laquée Blanc White Lackered	Inox. A2 Inox. A2 Stainless steel A2	Inox. A2 Lacado Negro Inox. A2 Laquée Noir Stainless steel A2 Black lackered	Caja Retail Box	Retractil Plastic Pack	Embalaje Pack Box
		pcs	pcs	pcs	pcs	pcs	pcs	pcs	pcs
Ø 4,2	4,2x14	32,35	43,50	83,25	153,50	210	500	4.000	16.000
	4,2x23	41,40	61,05	108,40	-	-	250	2.000	8.000

Tornillos para Carpintería de Aluminio / Vis pour profiles en Aluminium / Screws for aluminium profiles

Ref. FM

Fijación de marcos / Assemblage de cadres / Frame fixing

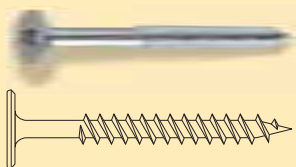

- Cabeza Extraplana
- **TORX® T20**

- Tête Extraplate
- **TORX® T20**

- Extra Low Head
- **TORX® T20**

Ventajas:

- Rosca doble filete polivalente para madera, taco de Nylon y metal.

Ventajas:

- Filet de pas rapide. Pour l'assemblage de cadres et fixation avec cheville nylon.

Ventajas:

- Twinfast thread. For frame joining and frame fixing with a nylon plug.

Aplicación:

- Para fijación de marcos sobre todo tipo de materiales. Su cabeza extraplana evita avellanar el aluminio y asegura una gran superficie de sujeción sobre el marco.

Application:

- Pour la fixation de cadres sur tous type de matériaux. Du fait de la tête extra plate de la vis FM, il n'est pas nécessaire de faire unamage sur le cadre en aluminium et assure une grande surface de serrage.

Application:

- For frame joining on all kind of materials. The extra low head avoids to countersunk the aluminium, assuring at the same time a large assembly surface on the frame.



		Precios / Prix / Prices (€/1000 u.)	Envasado / Conditionnement / Packing		
Diámetro Diamètre Diameter		Cincado Zingué Blanc Zinc Plated	Caja Retail Box	Retractable Plastic Pack	Embalaje Pack Box
			pcs	pcs	pcs
Ø 4,8	4,8x25	47,80	250	1.000	4.000
	4,8x35	59,15	250	1.000	4.000
	4,8x45	74,60	250	1.000	2.000
	4,8x55	94,25	250	1.000	2.000
	4,8x65	115,05	100	400	800
	4,8x75	128,55	100	400	800
	4,8x90	168,35	100	400	800

Ref. EMF

Tapón Envolvente Extraplano

Cache Vis pour Tête Extra Plate / Extra Thin Caps for Ref. FM



- Para Tornillo FM
- Tapón de Plástico

- Pour Vis FM
- Caché Plastique

- For Screw FM
- Plastic Cap

		Precios / Prix / Prices (€/1000 u.)	Envasado / Conditionnement / Packing		
Color Couleur Colour			Caja Retail Box	Retractable Plastic Pack	Embalaje Pack Box
			pcs	pcs	pcs
Blanco		30,40	1.000	4.000	8.000
Negro		30,40	1.000	4.000	8.000

Tornillos para Carpintería de Aluminio / Vis pour profiles en Aluminium / Screws for aluminium profiles

Ref. FCE

Fijación Corredera Europea

Pour Fixation de Ferrures sur Profiles PVC / For Fastening To PVC Profiles



- Cabeza Reducida 6,8 mm
- Philips (H)
- Rosca de uso polivalente

- Tête Réduite 6,8 Mm
- Philips (H)
- File Polyvalent

- Reduced Head 6,8 mm
- Philips (H)
- Versatile Thread

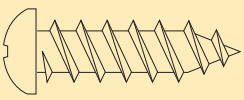

Aplicación:

- Para fijación de la corredera europea. Su cabeza reducida permite una fijación prácticamente invisible y rápida.

Application:

- Pour l'assemblage de cadres fenêtre. La tête réduite permet une fixation pratiquement invisible et un montage rapide.

Application:

- For frame joining and frame fixing. The reduced head allows a fast and invisible joining.

		Precios / Prix / Prices (€/1000 u.)	Envasado / Conditionnement / Packing		
Diámetro Diamètre Diameter		Cincado Zingué Blanc Zinc Plated	Caja Retail Box	Retractil Plastic Pack	Embalaje Pack Box
			pcs	pcs	pcs
Ø 4,5	4,5x30	44,60	500	4.000	16.000
	4,5x55	90,20	250	2.000	8.000
	4,5x70	106,75	250	1.000	4.000



Premarco de Madera:

- No requiere taladro previo.
- Empotramiento mínimo: 35mm.

Cadre en bois:

- Il n'est pas nécessaire de percer préalablement.
- Vissage minimum: 35mm.

Wood frame:

- It is not necessary to pre-drill.
- Minimum embedment: 35mm.



Taco en Pared.

- Requiere taladro previo broca y taco Ø 6.
- Empotramiento mínimo: 35mm.

Dans le béton.

- Utilisation d'une cheville Nylon de Ø 6.
- Vissage minimum: 35mm.

Plug in the wall.

- Drill a hole of Ø 6.
- Minimum embedment: 35mm.



Premarco Metálico:

- Requiere taladro previo: En Hierro: 3÷3,50 mm. En Aluminio: 3÷3,20 mm.
- Empotramiento: Mínimo: 8mm. Máximo: según grueso premarco.

Dans un profil métallique:

- En aluminium percer un trou de 3÷3,20mm. En acier percer un trou de de 3÷3,50mm.
- Insertion: Prise minimum de la vis 8mm. Maxime: selon épaisseur du cadre.

Metal frame:

- Drill a hole of 3÷3,5 mm on steel. In Aluminium 3÷3,20 mm
- Minimum embedment: 8 mm. Maximum: depending on the frame thickness.

Tornillos para Carpintería de Aluminio / Vis pour profiles en Aluminium / Screws for aluminium profiles

Ref. HM

Tornillos para Manillas y Herrajes Metálicos

Vis pour Poignés et Ferrures / Screw For Handles and Fitting

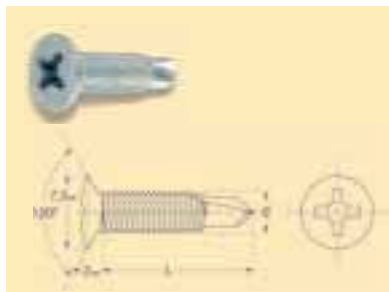

• Cabeza Gota Sebo 120° H2

• Punta Broca

• Rosca Métrica

• Tête Fraisée Bombée 120° H2

• Autoperceuse

• Vis à métaux

• Countersunk Raised Head 120° H2

• Selfdrilling

• Machine Screw

Características:

- Diseñado especialmente para la fijación de herrajes metálicos sobre puertas y ventanas de carpintería metálica (gruesos de 1÷2,5 mm en acero y 1,5-3 mm en aluminio).
- Cabeza avellanada gota de sebo de 120° que permite que la rosca llegue más arriba evitando que el tornillo se pase de rosca.

Description:

- Spécialement conçue pour la fixation de poignées sur les portes métalliques (épaisseur de tôle entre 1-1.5 mm en acier ou 1.5-3 mm en aluminium).
- Tête fraisée bombée de 120° qui permet de faire arriver le filetage sous la tête, pour éviter le foirage de l'assemblage.

Description:

- Specially designed for the assemblies on steel doors and aluminium profiles (thickness 1.5-2.5 mm in steel and 1.5-3 mm in aluminium).
- The thread reaches the top, blow the head, in order to improve the assembly stripping.
- Self drilling point nr 2 to improve the performance.

Aplicación:

- Para la fijación de cerraduras y contrcierres a puertas metálicas de hierro.

Application:

- Fixation de poignés et ferrures sur tôles de 1÷1.5 mm en acier.

Application:

- To fix handles and fitting on steel sheets 1÷1.5 mm thick. T



		Precios / Prix / Prices (€/1000 u.)				Envasado / Conditionnement / Packing		
Diámetro Diamètre Diameter		Cincado Zingué Blanc Zinc Plated	Cincado Negro Zingué Noir Black Zinc Plated	Latonado Laitonné Brass	Niquelado Nickelé Nickel	Caja Retail Box	Retractable Plastic Pack	Embalaje Pack Box
						pcs	pcs	pcs
Ø 4,0	4,0x10	25,95	-	-	37,75	500	4.000	16.000
	4,0x13	25,95	-	-	-	500	4.000	16.000
	4,0x16	28,55	41,65	41,65	-	500	4.000	16.000
	4,0x19	32,00	46,40	-	-	500	2.000	8.000
	4,0x25	35,55	51,60	46,40	-	500	2.000	8.000

Ref. PTM-45

Para Manillas y Herrajes Metálicos sobre Acero

Vis pour Poignés et Ferrures / Screw For Handles and Fittings

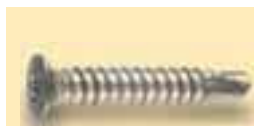

• Cabeza Gota Sebo 110° H2

• Punta Broca

• Recubrimiento Platinum (300 HNS)

• Tête fraisée bombée 120° H2

• Autoperceuse

• Revêtement Platinum (300 HSS)

• Countersunk raised head 120° H2

• Selfdrilling

• Platinum coating (300 HSS)



		Precios / Prix / Prices (€/1000 u.)		Envasado / Conditionnement / Packing		
Diámetro Diamètre Diameter		Cincado Zingué Blanc Zinc Plated		Caja Retail Box	Retractable Plastic Pack	Embalaje Pack Box
				pcs	pcs	pcs
Ø 4,0	4,0x13	26,20*		1.000	4.000	16.000
	4,0x16	26,80*		1.000	4.000	16.000
	4,0x19	28,95*		1.000	4.000	16.000
	4,0x25	34,95*		1.000	4.000	8.000
	4,0x32	42,05*		500	2.000	4.000
	4,0x38	48,05*		500	2.000	4.000

Tornillos para Carpintería de Aluminio / Vis pour profiles en Aluminium / Screws for aluminium profiles

Ref. FS



- Cabeza Baja (Forma Remache)
- Philips (H)
- Rosca Chapa
- Punta Forma C

- Tête Plate
- Empreinte Philips (H)
- Vis à Tôle
- Pointe C

- Low Head
- Philips Recess (H)
- Selftapping Screw
- C Point

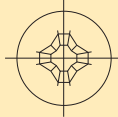
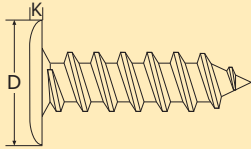

Ø	3,5	4,2	4,8
D	7	8,2	9,5
K	1,3	1,4	1,6
	H2	H2	H2

Medidas en mm / Mesures en mm / Measures in mm

Ventajas Técnicas:

- La cabeza de altura reducida mejora la estética del ensamblaje. Permite la utilización de este tornillo en aplicaciones donde usualmente se utilizan remaches. Evita la necesidad de avellanado de piezas donde la altura de la cabeza supone un problema.
- El cono reducido debajo de la cabeza permite un mejor apoyo sobre una superficie plana.

Avantages Techniques:

- La tête d'hauteur réduite apporte une amélioration d'esthétique à l'assemblage. Cette vis peut être utilisée à la place de rivets. Du fait de sa faible hauteur de tête il n'est pas nécessaire effectuer un fraisage sur la pièce.
- Le cone réduit sous tête permet un meilleur appui sur une surface plate.

Technical Advantages:

- The low head improves the aesthetical aspect of the assembly. This screw can be used where a rivet is usually used. It is not necessary to countersunk the pieces where the head highness could disturb.
- The reduced conus under the head allows a better sitting on a flat surface.



			Precios / Prix / Prices (€/1000 u.)			Envasado / Conditionnement / Packing		
Diámetro Diamètre Diameter			Cincado Zingué Blanc Zinc Plated	Cincado Negro ¹ Zingué Noir ¹ Black Zinc Plated ¹	Lacado Blanco Laquée Blanc White Lackered	Caja Retail Box	Retractil Plastic Pack	Embalaje Pack Box
			pcs	pcs	pcs	pcs	pcs	pcs
Ø 3,5 (N°6)	3,5 x 9,5	3/8	20,55	27,70	73,10	1.000	8.000	32.000
	3,5 x 13	1/2	21,75	-	75,00	500	4.000	16.000
	3,5 x 16	5/8	24,85	-	-	500	4.000	16.000
Ø 4,2 (N°8)	4,2 x 9,5	3/8	26,15	-	-	500	4.000	16.000
	4,2 x 13	1/2	26,15	39,80	-	500	4.000	16.000
	4,2 x 16	5/8	30,10	-	-	500	2.000	8.000
	4,2 x 19	3/4	32,75	-	-	500	2.000	8.000
	4,2 x 25	1	-	59,25*	-	250	2.000	8.000
Ø 4,8 (N°10)	4,8 x 13	1/2	44,10	-	-	500	2.000	8.000
	4,8 x 16	5/8	43,20	-	-	250	2.000	8.000
	4,8 x 19	3/4	48,20	70,00	-	250	2.000	8.000
	4,8 x 25	1	52,55	76,10*	-	250	1.000	4.000



* Hasta agotar existencias. * Fin serie. * End of stock.

Tornillos para Carpintería de Aluminio / Vis pour profiles en Aluminium / Screws for aluminium profiles

Ref. FST

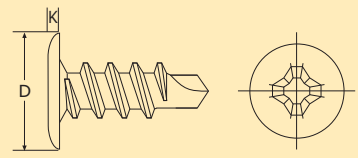

- Cabeza Baja Phillips (H)**
- Tête Plate Phillips (H)**
- Low Head Phillips (H)**
- Nueva gama Inox A2**
- Nouveau gamme Inox A2**
- New range Stainless Steel A2**
- Rosca Chapa**
- Vis à Tôle**
- Selftapping Screw**
- Punta Broca**
- Pointe Autoperceuse**
- Selfdrilling Screw**

Ø	3,5	4,2	4,8
D	7	8,2	9,5
K	1,3	1,4	2,1
	H2	H2	H2

Medidas en mm / Mesures en mm / Measures in mm

Ventajas Técnicas:

- La cabeza de altura reducida mejora la estética del ensamblaje. Permite la utilización de este tornillo en aplicaciones donde usualmente se utilizan remaches. Evita la necesidad de avellanado de piezas donde la altura de la cabeza supone un problema.
- El cono reducido debajo de la cabeza permite un mejor apoyo sobre una superficie plana.
- La punta taladro de la Ref. FST según norma DIN 7504 permite trabajar con chapas de espesor mayor que 1 mm.

Avantages Techniques:

- La tête d'hauteur réduite apporte une amélioration d'esthétique à l'assemblage. Cette vis peut être utilisée à la place de rivets. Du fait de sa faible hauteur de tête il n'est pas nécessaire effectuer un fraisage sur la pièce.
- Le cône réduit sous tête permet un meilleur appui sur une surface plate.
- La pointe autoperceuse faite selon la norme DIN 7504 permet de visser dans des tôles d'épaisseur supérieure à 1 mm.

Technical Advantages:

- The low head improves the aesthetical aspect of the assembly. This screw can be used where a rivet is usually used. It is not necessary to countersunk the pieces where the head height could disturb.
- The reduced conus under the head allows a better sitting on a flat surface.
- The selfdrilling point of Ref. FST as per norm DIN 7504 allows to drill steel plates with thickness over 1 mm.



**PATENTADO
REGISTRÉ
PATENTED**

			Precios / Prix / Prices (€/1000 u.)				Envasado / Conditionnement / Packing		
Diámetro Diamètre Diameter			Cincado Zingué Blanc Zinc Plated	Cincado Negro Zingué Noir Black Zinc Plated	Lacado Blanco Laquéé Blanc White Lackered	Inox. A2 ¹ Inox. A2 Stainless steel A2 ¹	Caja Retail Box	Retractil Plastic Pack	Embalaje Pack Box
							pcs	pcs	pcs
Ø 3,5 (N° 6)	3,5 x 9,5	3/8	26,95	37,15	78,50	104,50	1.000	8.000	32.000
	3,5 x 13	1/2	28,55	41,65	80,65	-	500	4.000	16.000
	3,5 x 16	5/8	29,45	-	-	-	500	4.000	16.000
Ø 4,2 (N° 8)	4,2 x 13	1/2	38,10	55,45	90,55	154,00	500	4.000	16.000
	4,2 x 16	5/8	39,00	58,50	-	165,00	500	2.000	8.000
	4,2 x 19	3/4	45,55	65,00	-	181,50	500	2.000	8.000
	4,2 x 25	1	57,60	-	-	-	250	2.000	8.000
Ø 4,8 (N° 10)	4,2 x 32	1-1/4	60,60	-	-	-	250	1.000	4.000
	4,8 x 13	1/2	56,75	-	-	176,00	500	4.000	16.000
	4,8 x 16	5/8	56,75	-	-	209,00	250	2.000	8.000
	4,8 x 19	3/4	65,40	-	-	220,00	250	2.000	8.000
	4,8 x 25	1	77,60	-	-	253,00	250	2.000	8.000
	4,8 x 32	1-1/4	81,60	-	-	-	250	1.000	4.000
	4,8 x 38	1-1/2	93,30	-	-	-	250	1.000	4.000

¹ Para taladro aluminio. ¹ Pour perçage en aluminium. ¹ Selfdrilling to aluminium.
* Hasta agotar existencias. * Fin serie. * End of stock.

L (mm)	Ø 3,5	Ø 4,2	Ø 4,8	Ø 5,5	Ø 6,3
9,5	3	-	-	-	-
13	7	6	5	-	-
16	10	9	8	-	-
19	13	12	11	9	8
22	16	15	14	12	11
25	19	18	17	15	14
32	-	25	24	22	21
38	-	31	30	28	27
45	-	-	37	35	34
50	-	-	42	40	39
G Máx (mm)	2	3	4	5	6

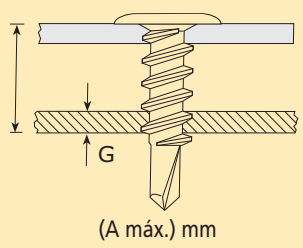

Tornillos para Carpintería de Aluminio / Vis pour profiles en Aluminium / Screws for aluminium profiles

Tornillo Envolvente Rosca Chapa

Vis à Tôle avec caches plastique / Selftapping with plastic cover caps



CA-HP
PHILIPS
PUNTA C
POINTE C
C POINT

CA-HP INOX A2
PHILIPS
PUNTA C
POINTE C
C POINT

CA-H
PHILIPS
PUNTA GUÍA
POINTE GUIDE
GUIDE POINT

CAHP-S
S 25
PUNTA C
POINTE C
C POINT

TEC
PHILIPS
PUNTA BROCA
AUTOPERCEUSE
SELFD RILLING

Descripción:

• Tornillo de cabeza envolvente para clipado de tapón de plástico. Ref. CA-T o T-12

Description:

• Vis avec tête conçue pour le clipage d'un cache vis en plastique. Ref. CA-T ou T-12.

Description:

• Screw with special head to clip a plastic cap. Ref. CA-T or T-12.

Aplicación:

• En ensamblajes donde se requiera una mejora estética o bien una protección suplementaria a la corrosión.

Application:

• Assemblages avec esthétique amélioré ou bien pour augmenter la tenue à la corrosion.

Application:

• Assemblies where a improved aesthetics is needed. It protects against corrosion.



		Precios / Prix / Prices (€/1000 u.)					Envasado / Conditionnement / Packing		
Diámetro Diamètre Diameter		CA-HP	CA-HP	CA-H	CAHP-S	TEC	Caja	Retractil	Embalaje
		Cincado Zingué Blanc Zinc Plated	Inox. A2 Inox. A2 Stainless steel A2	Cincado Zingué Blanc Zinc Plated	Cincado Zingué Blanc Zinc Plated	Cincado Zingué Blanc Zinc Plated	Retail Box	Plastic Pack	Pack Box
		pcs	pcs	pcs	pcs	pcs	pcs	pcs	
Ø 4,2	4,2x19	43,85	-	50,15*	-	-	500	2.000	8.000
	4,2x25	48,00	-	55,00	-	-	250	1.000	4.000
	4,2x32	62,20	-	71,10	-	-	250	1.000	4.000
Ø 4,8	4,8x13	35,80	132,85	-	-	-	500	2.000	8.000
	4,8x16	40,55	139,15	-	-	-	250	2.000	8.000
	4,8x19	43,85	151,80	-	-	-	250	2.000	8.000
	4,8x25	52,05	177,10	59,45	58,80	63,10	250	1.000	4.000
	4,8x32	62,20	189,75	71,10	70,05	74,40	250	1.000	4.000
	4,8x38	68,95	215,05	-	77,70	84,50	250	1.000	2.000
	4,8x45	-	-	-	-	103,35	250	1.000	2.000
	4,8x50	109,10	265,65	124,70*	122,85	117,30	250	1.000	2.000
	4,8x60	132,50	341,55	-	155,40	151,35	250	1.000	2.000
	4,8x70	153,75	480,70	-	194,25	-	100	400	800
Ø 5,5	5,5x13	50,25	-	-	-	-	250	2.000	8.000
	5,5x16	52,35	-	-	-	-	250	1.000	4.000
	5,5x19	55,85	177,10	63,85*	-	-	250	1.000	4.000
	5,5x25	63,45	215,05	72,55	71,40	-	250	1.000	4.000
	5,5x32	86,15	246,70	-	-	-	250	1.000	4.000
	5,5x38	94,20	265,65	-	106,05	-	250	1.000	2.000
	5,5x50	130,00	309,95	-	145,95	-	250	1.000	2.000
	5,5x60	163,65	385,85	-	189,00	-	100	400	800
	5,5x70	187,90	493,35	-	231,00	-	100	400	800
	5,5x80	234,80	-	-	-	-	100	400	800
	5,5x90	257,45	-	-	-	-	100	400	800
	5,5x100	302,10	-	-	-	-	100	400	800

Ref. CA-T

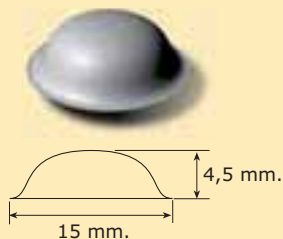

- Tapón para Tornillo Ref.: CA-HP, CA-H, CAHP-S, TEC, TEC-PLAST

- Caches Plastiques pour les Vis Ref. CA-HP, CA-H, CAHP-S, TEC, TECPLAST

- Plastic Caps for Screws Ref. CA-HP, CA-H, CAHP-S, TEC, TECPLAST



Colores Couleurs Colours	Precios / Prix / Prices (€/1000 u.)	Envasado / Conditionnement / Packing		
		Caja Retail Box	Retractil Plastic Pack	Embalaje Pack Box
Blanco/Negro/Gris Blanc/Noir/Gris White/Black/Grey	CA-T 26,05	pcs 1.000	pcs 4.000	pcs 8.000

Ref. T-12



- Tapón para Tornillo Ref.: CA-HP, CA-H, CAHP-S, TEC, TEC-PLAST

- Caches Plastiques pour les Vis Ref. CA-HP, CA-H, CAHP-S, TEC, TECPLAST

- Plastic Caps for Screws Ref. CA-HP, CA-H, CAHP-S, TEC, TECPLAST

Ventajas:

- Tapón para todos los tornillos envolventes. Su Ø exterior, menor que el del CA-T, permite la colocación del tapón en perfiles con poco espacio.

Avantages:

- Le Ø extérieur permet l'utilisation dans des applications avec dimensions réduites.

Advantages:

- The smaller Ø allows its use in small places on aluminium profiles.

Color Couleur Colour	Precios / Prix / Prices (€/1000 u.)	Envasado / Conditionnement / Packing		
		Caja Retail Box	Retractil Plastic Pack	Embalaje Pack Box
Blanco	T-12 30,05	pcs 1.000	pcs 4.000	pcs 8.000
Negro	30,05	1.000	4.000	8.000

■ Ref. TEC PLAST

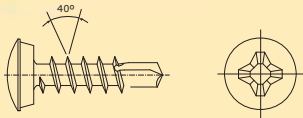

- Tornillo Envolvente
- Rosca Plástico
- Philips (H2)
- Punta Broca

- Avec Caches Plastique
- Filet Plastique
- Philips (H2)
- Autoperceuse

- Plastic Cover Caps
- Plastic Thread
- Philips (H2)
- Selfdrilling

Características:

- Tornillo con cabeza envolvente para tapón T12 o CA-T, con punta broca y rosca para plástico.

Aplicaciones:

- Fijación de matrículas a soportes plásticos (parachoques).
- Mayor resistencia a la extracción al tener rosca especial para plásticos.
- Fijación directa, no necesita pretaladro.

Caractéristiques:

- Vis avec tête pour caches en plastique type T12 ou CA-T, avec pointe autoperceuse and filet pour plastiques.

Applications:

- Pour fixer les plaques d'immatriculation sur les parechoques.
- Meilleure tenue à l'arrachement.
- Assemblage sans avoir besoin d'un foret.

Characteristics:

- Screws with head for caps (type T12 or CA-T) and plastic thread.

Applications:

- To fix the license plates on the bumpers.
- Better pull-out resistance.
- Assembly without pre-drilled hole.



		Precios / Prix / Prices (€/1000 u.)	Envasado / Conditionnement / Packing		
Diámetro Diamètre Diameter		Cincado Zingué Blanc Zinc Plated	Caja Retail Box	Retractil Plastic Pack	Embalaje Pack Box
			pcs	pcs	pcs
Ø 5,1	5,1x19	62,70	250	1.000	4.000

Tornillos Carpintería de Aluminio / Vis pour Profiles en Aluminium / Screws for Aluminium Profiles

Ref. 7981-0 Tornillo Guía / Vis Pointe Guide / Leader Point Screw



• Punta Guía

• Pointe Guide

• Guide Point

Características:

- Tornillo rosca chapa igual al DIN 7981 pero con punta guía, forma cilíndrica.

Aplicaciones:

- Para unión de perfiles de aluminio; la punta guía permite que el tornillo quede perfectamente guiado en el aluminio, facilitando el atornillado desde el inicio.

Caractéristiques:

- Vis à tête identique à la DIN 7981 mais avec pointe cylindrique servant de guide.

Applications:

- Pour la fixation de profilés en aluminium; la pointe guide permet un positionnement de la vis dans le profilé.

Characteristics:

- Selftapping screw as per DIN 7981 but with cylindrical guide point.

Applications:

- For aluminium profiles fixation; the guide point allows a perfect positioning into the aluminium profile.



		Precios / Prix / Prices (€/1000 u.)		Envasado / Conditionnement / Packing		
Diámetro Diamètre Diameter		Cincado Zingué Blanc Zinc Plated	Inox A2 Inox A2 Stainless Steel A2	Caja Retail Box	Retractable Plastic Pack	Embalaje Pack Box
				pcs	pcs	pcs
Ø 4,2	4,2x19	27,00	95,35	500	2.000	8.000
	4,2x22	-	98,40*	250	2.000	8.000
	4,2x25	32,60	104,95	250	2.000	8.000
Ø 4,8	4,8x19	38,70	114,45	250	2.000	8.000
	4,8x22	-	146,10	250	2.000	8.000
	4,8x25	41,90	-	250	1.000	4.000
Ø 5,5	5,5x19	47,90*	-	250	1.000	4.000
	5,5x25	55,10	-	250	1.000	4.000

* Hasta agotar existencias. * Fin serie. * End of stock.

Refs. CHJ/RJ/TJ/CHJ-H

Remaches y Tornillos Junquillo de Sujeción / Vis de Clipsage Clipping Screws



• Junquillo Rosca Chapa (CHJ)

• Vis à Tôle (CHJ)

• Selftapping Screw (CHJ)

• Junquillo Rosca Rápida (RJ)

• Vis Rapide (RJ)

• Quick Thread (RJ)

• Junquillo Rosca Whitworth (TJ)

• Filet Whitworth (TJ)

• Whitworth Thread (TJ)

• Junquillo Rosca Chapa H2, (CHJ-H)

• Vis à Tôle H2 (CHJ-H)

• Selftapping Screw H2 (CHJ-H)

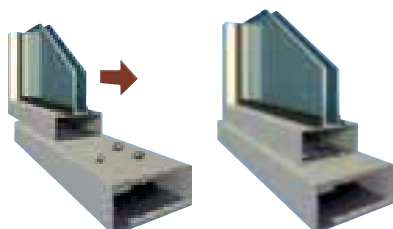

Datos		Precios / Prix / Prices (€/1000 u.)		Envasado / Conditionnement / Packing		
Diámetro Diamètre Diameter		Cincado Zingué Blanc Zinc Plated		Caja Retail Box	Retractable Plastic Pack	Embalaje Pack Box
				pcs	pcs	pcs
Ø 4,2	CHJ		31,75	1.000	4.000	16.000
Ø 4,6	RJ		25,65	1.000	4.000	16.000
Ø W 3/16	TJ		28,60	1.000	4.000	16.000
Ø 4,2	CHJ-H		32,75	1.000	4.000	16.000

Tornillos Carpintería de Aluminio / Vis pour Profiles en Aluminium / Screws for Aluminium Profiles

DIN 7991 / DIN 965

Tornillos para Escuadras / Vis pour Équerre / Screw for Corners

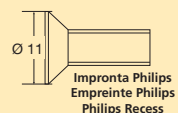
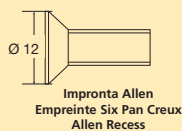

- **Tornillo Rosca Métrica**
- **Cabeza Avellanada**

- **Vis à Filet Métrique**
- **Tête Fraisée**

- **Metric Thread Screw**
- **Countersunk Head**

		Precios / Prix / Prices (€/1000 u.)	Envasado / Conditionnement / Packing	
Diámetro Diamètre Diameter		Cincado Zingué Blanc Zinc Plated	Caja Retail Box	Embalaje Pack Box
			pcs	pcs
965	M6 x 12	48,30	250	8.000
7991	M6 x 12	71,80	250	8.000

Ref. CM Tornillos para Persianas

Vis pour Volets Roulants / Screws for Rolling Shades



- **Cabeza Extraplana con Arandela Estampada**
- **Pozi (Z)**
- **Filete Agudo 40°**

- **Vis à Tête Extra Plate et Embase.**
- **Pozi (Z)**
- **Filet à 40°**

- **Extra Low Head Screw and Large Washer.**
- **Pozi (Z)**
- **40° thread**

Aplicaciones:

- Para la fijación de tiradores de madera, traseras de armario, capialzados de madera (evita el uso de ovalillos), etc.

Applications:

- Pour la fixation des tiroirs en bois et fond des armoires, et pour les volet, roulant, enbois.

Applications:

- For fixing wood knobs and thin wood panels.

		Precios / Prix / Prices (€/1000 u.)	Envasado / Conditionnement / Packing		
Diámetro Diamètre Diameter		Bicromatado Bichromaté Yellow Zinc Plated	Caja Retail Box	Retractable Plastic Pack	Embalaje Pack Box
			pcs	pcs	pcs
Ø 3,0	3,0x20	24,50	1.000	4.000	8.000
	3,0x25	25,90	1.000	4.000	8.000
	3,0x30	36,90	1.000	4.000	8.000
	3,0x35	39,50	500	2.000	4.000
Ø 3,5	3,5x10	24,15	1.000	4.000	16.000
	3,5x15	25,35	1.000	4.000	16.000
Ø 4,0	4,0x17	29,50	1.000	4.000	8.000
	4,0x20	31,20	1.000	4.000	8.000
	4,0x25	35,00	1.000	4.000	8.000
	4,0x30	41,30	500	2.000	4.000
	4,0x35	48,70	500	2.000	4.000
	4,0x40	53,10	500	2.000	4.000
	4,0x45	66,55	250	1.000	2.000

Tornillos Carpintería de Aluminio / Vis pour Profiles en Aluminium / Screws for Aluminium Profiles

Ref. CP

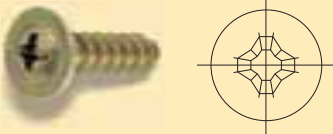

- Cabeza Alomada Baja
- Philips N° 2
- Rosca Plástico

- Tête Cylindrique Bombée Basse
- Philips N° 2
- Filet Plastique

- Low Pan Head
- Philips N° 2
- Plastic Thread

Aplicaciones:

• Para el cierre de capitalizados de plástico (3,5 x 10) y PVC prensado (4 x 17). De aplicación directa, no requiere taladro previo. Su rosca especial para plásticos permite desatornillar y atornillar varias veces y facilitan el rápido acceso a la persiana.

Applications:

• Pour fixation de panneaux plastiques de faible épaisseur. S'utilise sans percer préalablement. Le filet spécial pour plastique permet de visser et dévisser plusieurs fois.

Applications:

• To fix thin plastic panels. The special thread for plastics allows drive in/out several times. pre-drill is required.

		Precios / Prix / Prices (€/1000 u.)	Envasado / Conditionnement / Packing		
Diámetro Diamètre Diameter		Bicromatado Bichromaté Yellow Zinc Plated	Caja Retail Box	Retractable Plastic Pack	Embalaje Pack Box
			pcs	pcs	pcs
Ø 3,5	3,5x10	24,15	1.000	4.000	16.000
Ø 4,0	4x17	30,95	1.000	4.000	8.000

**Ref. PCL Tornillos para Persianas de Aluminio
Vis pour Volets en Aluminium / Screw for Rolling Shades in Aluminium**



- Cabeza Alomada
- Punta Clavo
- Ranurado
- Rosca Chapa

- Tête Cylindrique Bombée
- Pointe Clou
- Vis à Tôle

- Pan Head
- Nail Point
- Slotted
- Selftapping Screw

Aplicaciones:

• Para la sujeción de persianas al eje donde se enrollan.

Applications:

• Pour la fixation de volets roulants à son axe.

Applications:

• For blind joining to the axe

		Precios / Prix / Prices (€/1000 u.)	Envasado / Conditionnement / Packing
Diámetro Diamètre Diameter		Cincado Zingué Blanc Zinc Plated	Bolsas de Plástico Sachet Plastique Plastic Bags
Ø 3,9	3,9x28	52,80*	1.000

Tornillos para Fijación de Marcos / Vis pour la Fixation de Cadres / Screws for Frame Joining

Ref. MF MARCFIX

Para Fijación de Marcos

Pour la Fixation de Cadres / For Frame Joining

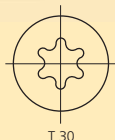

- Tornillo para Montaje Rápido de Marcos Sobre Hormigón, Ladrillo o Madera

- Vis pour la Fixation Des Cadres Directement Sur Béton Ou Brique

- Screw for Frame Joining to Brick Or To Concrete

Ventajas:

- Gran rapidez de montaje.
- Utilizable con todo tipo de materiales (ladrillo, hormigón, madera, etc.).
- Fijación fuerte del tornillo sobre la obra (sin tacos intermedios).
- La fijación no crea tensiones de expansión sobre la pared.

Avantages:

- Rapidité d'assemblage.
- On peut l'utiliser dans tous les types de matériaux.
- Bonne tenue de la vis dans les murs (sans cheville).
- La fixation ne provoque pas de tension interne après l'assemblage.

Advantages:

- Quick assembly work.
- Can be used on all kind of materials.
- Strong holding on the wall (without plugs).
- No stress forces are generated on the base material after assembly.

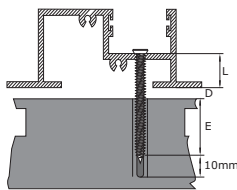

LONGITUD DEL TORNILLO A UTILIZAR $L = D + E$
LONGUEUR DE LA VIS À UTILISER $L = D + E$
SCREW LENGTH TO USE $L = D + E$

Marcos de PVC
Cadres PVC
PVC Frames



Hormigón
Béton
Concrete

		Precios / Prix / Prices (€/1000 u.)	Envasado / Conditionnement / Packing		
Diámetro Diamètre Diameter	MF Marcfix		Caja Retail Box	Retractil Plastic Pack	Embalaje Pack Box
			pcs	pcs	pcs
Ø7,5	7,5 x 42	196,55	100	400	800
	7,5 x 62	229,30	100	400	800
	7,5 x 72	283,90	100	400	800
	7,5 x 92	414,95	100	400	800
	7,5 x 112	491,40	100	400	800
	7,5 x 132	655,20	100	400	800
	7,5 x 152	764,40	100	400	800
7,5 x 182	1.070,15	100	100	400	

Requiere taladro previo con broca de 6 mm. / Il est nécessaire de percer préalablement un trou de diamètre 6 mm.
Pre-drilling a 6 mm hole is required.

Ref. TMF



- Tapón Embellecedor

- Cache en Plastique

- Plastic Cap

		Precios / Prix / Prices (€/1000 u.)	Envasado / Conditionnement / Packing		
Color Couleur Colour	TMF		Caja Retail Box	Retractil Plastic Pack	Embalaje Pack Box
			pcs	pcs	pcs
Blanco	35,85	250	1.000	4.000	
Negro	35,85	250	1.000	4.000	

Tornillos para Fijación de Marcos / Vis pour la Fixation de Cadres / Screws for Frame Joining

Ref. MFC MARCFIX
Para Fijación de Marcos
Pour la Fixation de Cadres / For Frame Joining

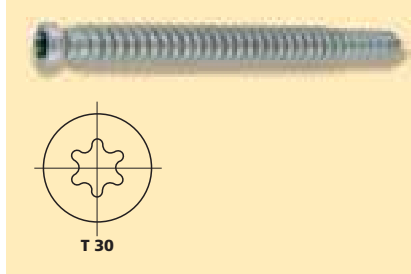

- | | | |
|---|---------------------------------------|--------------------------------------|
| • Cabeza Cilíndrica | • Tête Cylindrique | • Cylindric Head |
| • TORX® 30 | • TORX® 30 | • TORX® 30 |
| • Rosca Progresiva para Marco de Madera | • Filet Progressif pour Cadre en Bois | • Progressive Thread for Wood Frames |

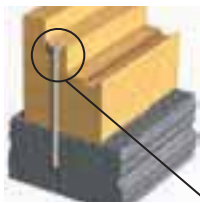

Marcos de Madera
Cadres en bois
Wood Frames

Madera
Bois
Wood

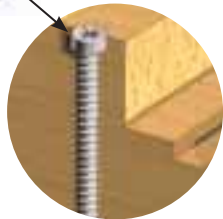

		Precios / Prix / Prices (€/1000 u.)	Envasado / Conditionnement / Packing		
Diámetro Diamètre Diameter		MFC Marcfix	Caja Retail Box	Retrictil Plastic Pack	Embalaje Pack Box
			pcs	pcs	pcs
Ø 7,5	7,5 x 72	280,00	100	400	800
	7,5 x 92	410,00	100	400	800
	7,5 x 112	500,00	100	400	800

Requiere taladro previo con broca de 6 mm. / Il est nécessaire de percer préalablement un trou de diamètre 6 mm.
Pre-drilling a 6 mm hole is required.

Empotramiento Mínimo Recomendado Profondeur Minimum de Tenue Recommandée / Minimum Embedment	
Tipo de Material Type de Matériaux / Material Type	Empotramiento / Insertion / Embedment
	(mm)
Hormigón/Béton/Concrete	30
Piedra/Pierre/Stone	40
Ladrillo macizo/Brique/Brick	40
Madera/Bois/Wood	50-60
Ladrillo Hueco (min 2 cavidades)/Brique creuse/Brick (minimum 2 holes)	60



Solicite nuestro catálogo especializado en Tornillería para PVC
Demandez notre catalogue technique de vis pour PVC.

Ask for our technical catalogue about screws for PVC

NUEVO NOUVEAU NEW PLATINUM

plus

Grupo CELO

*Tornillos Especiales para
Cerramientos de PVC*

*Vis Spéciales pour
Profilés en PVC*

*Special Screws for PVC
Window Frames*

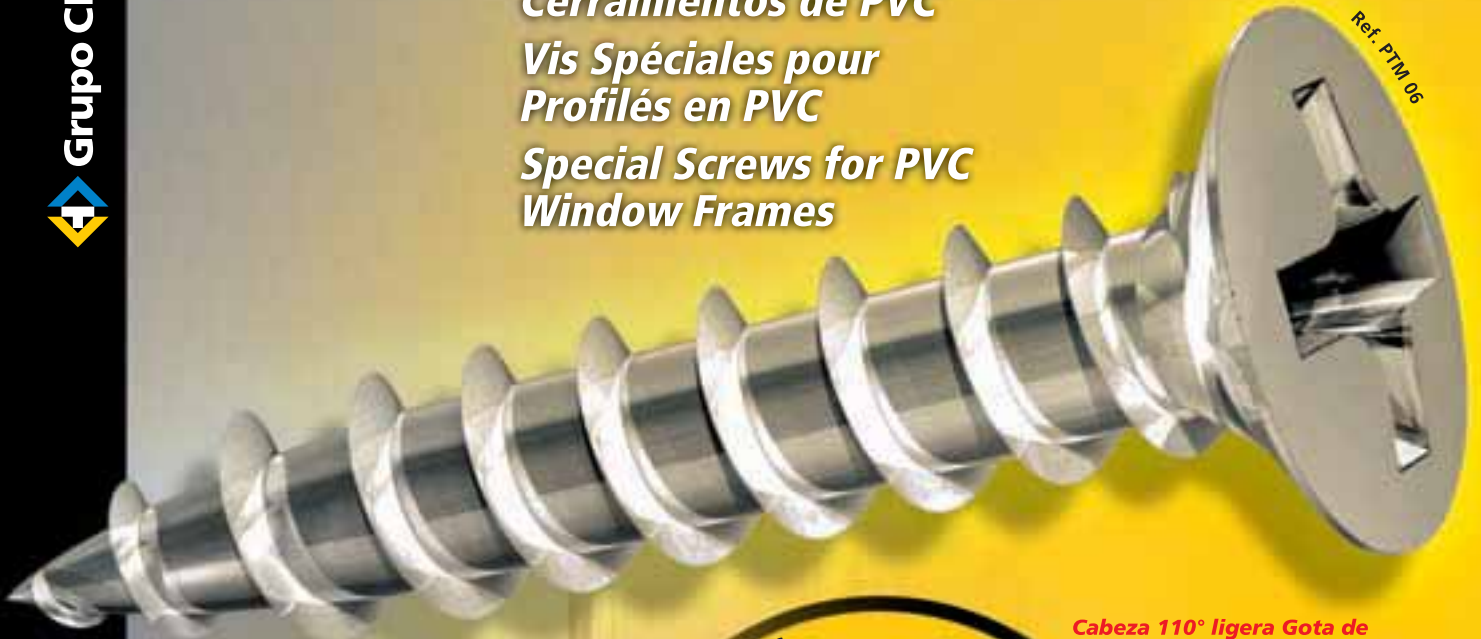

Super Broca "PIT DRILL" Especial PVC.
Pointe Autoperceuse "PIT DRILL"
Renforcement spécial pour perçage du PVC.
Stronger Drilling Point "PIT DRILL"
Specially designed for PVC frames.

Cabeza 110° ligera Gota de Sebo, con 4 estrías.

Doble función, según aplicación, avellana el PVC y reduce el pasado de rosca en contacto con el herraje.

La Tête fraisée bombée à 110° avec crans pour éviter le foirage.

Permet de garantir un appui parfait sur la pièce à fixer, même en montage oblique.

Countersunk head (110°) with 4 serrations.

For a perfect fit in the fittings.



ÓPTIMO PARA
**ATORNILLADO
AUTOMÁTICO**

VIS OPTIMALE
**POUR VISSAGE
AUTOMATIQUE**

HIGH PERFORMANCE
**IN AUTOMATIC
ASSEMBLIES**

Acabado cincado "PLATINUM"
Revêtement "PLATINUM"
"PLATINUM" Coated

ELEVADA RESISTENCIA A LA CORROSIÓN (300 HNS).
Resistencia superior a un bicromatado y similar a la que ofrecen los actuales herrajes de PVC.

HAUTE RÉSIDANCE À LA CORROSION (300 HSS).
HIGH CORROSION RESISTANCE (300 HSS).

**CELO SELECT
MAXIMUM 100ppm**

Fijación al Refuerzo de Acero / Fixation de Renfort / Reinforcement Fixation

Ref. PVE 46



NEW

- | | | |
|--|--|---|
| <ul style="list-style-type: none"> • Cabeza Avellanada 90° • Especial Máquinas Automáticas y Semiautomáticas • Punta Broca PIT DRILL • Con Micro-Estrias | <ul style="list-style-type: none"> • Tête Fraisée 90° • Spécial Machines Automatiques et Semi-automatiques • Autoperceuse PIT DRILL • Avec Micro Crans | <ul style="list-style-type: none"> • Countersunk Head 90° • Special for automatic and semi-automatic Machines. • Selfdrilling PIT DRILL • With Micro Serrations |
|--|--|---|

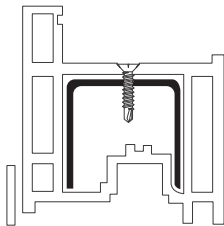

		Precios / Prix / Prices (€/1000 u.)	Envasado / Conditionnement / Packing		
Diámetro Diamètre Diameter		Cincado Zingué Blanc Zinc Plated	Caja Retail Box	Retractil Plastic Pack	Embalaje Pack Box
			pcs	pcs	pcs
Ø 3,9	3,9x13	22,20	1.000	4.000	16.000
	3,9x16	22,85	1.000	4.000	16.000
	3,9x19	24,65	1.000	4.000	8.000

Ref. PTM-47



NEW

- | | | |
|---|---|--|
| <ul style="list-style-type: none"> • Cabeza Gota Sebo 110° • Especial Máquinas Automáticas y Semiautomáticas • Punta Broca PIT DRILL • Platinum (300 HNS) • Especial Fijación Herrajes | <ul style="list-style-type: none"> • Tête Fraisée Bombée 110° • Spécial Machines Automatiques et Semi-Automatiques • Autoperceuse PIT DRILL • Platinum (300 HSS) • Special Fixation Ferrures | <ul style="list-style-type: none"> • Raised Countersunk Head 110° • Special for Automatic and Semi-Automatic Machines • Self Drilling PIT DRILL • Platinum (300 HSS) • Special for Fitting Fixation |
|---|---|--|

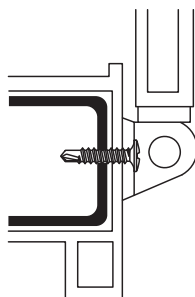

		Precios / Prix / Prices (€/1000 u.)	Envasado / Conditionnement / Packing		
Diámetro Diamètre Diameter		Platinum	Caja Retail Box	Retractil Plastic Pack	Embalaje Pack Box
			pcs	pcs	pcs
Ø 3,9	3,9x13	26,20	1.000	4.000	16.000
	3,9x16	26,80	1.000	4.000	16.000
	3,9x19	28,95	1.000	4.000	16.000
	3,9x25	34,95	1.000	4.000	8.000
	3,9x32	42,05	500	2.000	4.000
	3,9x38	48,05	500	2.000	4.000

Ref. PV-20



- | | | |
|--|---|--|
| <ul style="list-style-type: none"> • Cabeza Alomada | <ul style="list-style-type: none"> • Tête Cylindrique Bombée | <ul style="list-style-type: none"> • Pan Head |
|--|---|--|

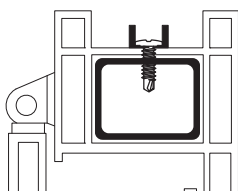

		Precios / Prix / Prices (€/1000 u.)	Envasado / Conditionnement / Packing		
Diámetro Diamètre Diameter		Bicromatado Bichromaté Yellow Zinc Plated	Caja Retail Box	Retractil Plastic Pack	Embalaje Pack Box
			pcs	pcs	pcs
Ø 3,9	3,9x13	23,85	500	4.000	16.000
	3,9x16	25,20	500	2.000	8.000
	3,9x19	27,20	500	2.000	8.000

Fijación al Refuerzo de Acero / Fixation de Renfort / Reinforcement Fixation

Ref. PVE 43 / PV45*



- | | | |
|---|--|---|
| <ul style="list-style-type: none"> • Cabeza Avellanada 90° • Especial Semiautomaticas | <ul style="list-style-type: none"> • Tête Fraisée 90° • Spécial Machines Semi-automatiques | <ul style="list-style-type: none"> • Countersunk Head 90° • Special for Semi-automatic Machines |
|---|--|---|



		Precios / Prix / Prices (€/1000 u.)		Envasado / Conditionnement / Packing		
Diámetro Diamètre Diameter		Cincado Zingué Blanc Zinc Plated	Bicromatado Bichromaté Yellow Zinc Plated	Caja Retail Box	Retractil Plastic Pack	Embalaje Pack Box
				pcs	pcs	pcs
Ø 4,0	4,0x13	16,15	16,15	1.000	4.000	16.000
	4,0x16	17,75	17,75	1.000	4.000	16.000
	4,0x19	20,50	20,50	1.000	4.000	16.000
	4,0x25	24,15	24,15	1.000	4.000	8.000
	4,0x32	30,45	30,45	500	2.000	8.000
	4,0x38	36,75	36,75	500	2.000	8.000

* Hasta agotar existencias. * Fin serie. * End of stock.

Ref. PV-55



- | | | |
|--|--|--|
| <ul style="list-style-type: none"> • Cabeza Avellanada 90° • Especial Perfiles Doble Cámara • Rosca Métrica • Para Aplicación Manual | <ul style="list-style-type: none"> • Tête Fraisée 90° • Spécial Profile Double Chambre • Vis Métrique • Application Manual | <ul style="list-style-type: none"> • Countersunk Head 90° • Special Double Chamber Frame • Machine Thread • Manual Application |
|--|--|--|

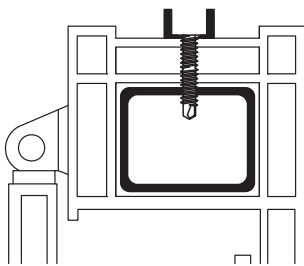

		Precios / Prix / Prices (€/1000 u.)		Envasado / Conditionnement / Packing		
Diámetro Diamètre Diameter		Cincado Zingué Blanc Zinc Plated	Bicromatado Bichromaté Yellow Zinc Plated	Caja Retail Box	Retractil Plastic Pack	Embalaje Pack Box
				pcs	pcs	pcs
Ø 4,0	4,0x13	19,80	19,80	500	4.000	16.000
	4,0x16	21,20	21,20	500	4.000	16.000
	4,0x19	24,15	24,15	500	2.000	8.000
	4,0x25	28,65	28,85	500	2.000	8.000
	4,0x32	33,60	33,60	500	2.000	4.000
	4,0x38	34,25	34,25	500	2.000	4.000
	4,0x45	41,50	-	500	2.000	4.000

Ref. PV-40



- | | | |
|---|---|---|
| <ul style="list-style-type: none"> • Cabeza Avellanada 90° • Taladro con Sección Piloto • Espesores a Fijar entre 5 y 9 mm | <ul style="list-style-type: none"> • Tête Fraisée 90° • Autoperceuse Avec Long Foret • Épaisseur entre 5 et 9 mm | <ul style="list-style-type: none"> • Countersunk Head 90° • Selfdrilling Pilot Point • From 5 to 9mm Thickness |
|---|---|---|

		Precios / Prix / Prices (€/1000 u.)		Envasado / Conditionnement / Packing		
Diámetro Diamètre Diameter		Bicromatado Bichromaté Yellow Zinc Plated		Caja Retail Box	Retractil Plastic Pack	Embalaje Pack Box
				pcs	pcs	pcs
Ø 3,9	3,9x16		23,85	500	4.000	16.000
	3,9x19		23,95	500	2.000	8.000
	3,9x25		28,45	500	2.000	8.000

Fijación al Perfil de PVC / Fixation de Ferrures et Gâches / Fixation on PVC Profile

Ref. PVE 04



NEW

- | | | |
|--|---|--|
| <ul style="list-style-type: none"> • Cabeza Avellanada 90° • Con 4 estrias • Rosca Plástico • Punta S • Cabeza Ø 7 mm | <ul style="list-style-type: none"> • Tête Fraisée 90° • 4 Crans • Filet Plastique • Pointe S • Tête Ø 7 mm | <ul style="list-style-type: none"> • Countersunk Head 90° • 4 Serrations • Plastic Thread • S Point • Head Ø 7 mm |
|--|---|--|

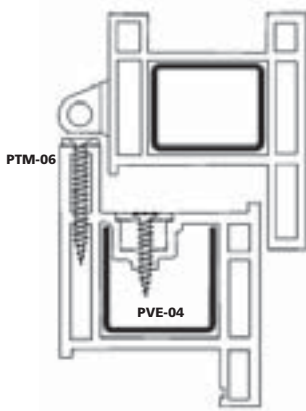

Diámetro Diamètre Diameter		Precios / Prix / Prices (€/1000 u.)			Envasado / Conditionnement / Packing		
		Cincado Zingué Blanc Zinc Plated	Bicromatado Bichromaté Yellow Zinc Plated	Lacado Blanco Laqué Blanc White Lackered	Caja Retail Box	Retractil Plastic Pack	Embalaje Pack Box
					pcs	pcs	pcs
Ø 4,1	4,1x16	18,30	18,30	-	1.000	4.000	8.000
	4,1x19	19,90	19,90	-	1.000	4.000	8.000
	4,1x22	20,80	-	-	1.000	4.000	8.000
	4,1x25	23,30	23,30	63,05	1.000	4.000	8.000
	4,1x30	25,05	25,05	-	500	2.000	4.000
	4,1x38	31,00	31,00	84,75	500	2.000	4.000
	4,1x45	36,15	36,15	-	500	2.000	4.000
	4,1x55	45,40	45,40	-	250	1.000	2.000

Ref. PTM-06

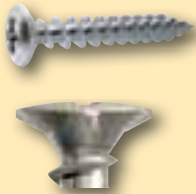

NEW

- | | | |
|---|---|---|
| <ul style="list-style-type: none"> • Cabeza Gota Sebo 110° • Con 4 estrias • Recubrimiento Platinum • Rosca Plástico • Punta S | <ul style="list-style-type: none"> • Tête Fraisée Bombée 110° • 4 Crans • Revêtement Platinum • Filet Plastique • Pointe S | <ul style="list-style-type: none"> • Raised Countersunk Head 110° • 4 Serrations • Platinum Coating • Plastic Thread • S Point |
|---|---|---|

Diámetro Diamètre Diameter		Precios / Prix / Prices (€/1000 u.)	Envasado / Conditionnement / Packing		
		Platinum	Caja Retail Box	Retractil Plastic Pack	Embalaje Pack Box
			pcs	pcs	pcs
Ø 4,1	4,1x16	21,05	1.000	4.000	8.000
	4,1x19	22,85	1.000	4.000	8.000
	4,1x22	24,05	1.000	4.000	8.000
	4,1x25	27,05	1.000	4.000	8.000
	4,1x30	28,80	500	2.000	4.000
	4,1x38	35,50	500	2.000	4.000
	4,1x45	41,45	500	2.000	4.000
	4,1x55	50,10	500	2.000	2.000

Fijación al Perfil de PVC / Fixation de Ferrures et Gâches / Fixation on PVC Profile

Ref. PV-00



- | | | |
|-------------------------|-------------------------|------------------------|
| • Cabeza Avellanada 90° | • Tête Fraisée 90° | • Countersunk Head 90° |
| • Doble Hilo High-Low | • Double Filet High-Low | • Double High-Low |
| • Punta S | • Pointe S | • S Point |
| • Cabeza Ø 7,5 mm | • Tête Ø 7,5 mm | • Head Ø 7,5 mm |

Diámetro Diamètre Diameter		Precios / Prix / Prices (€/1000 u.)			Envasado / Conditionnement / Packing		
		Cincado Zingué Blanc Zinc Plated	Bicromatado Bichromaté Yellow Zinc Plated	Lacado Blanco Laqué Blanc White Lacquered	Caja Retail Box	Retráctil Plastic Pack	Embalaje Pack Box
					pcs	pcs	pcs
Ø 3,9	3,9x16	15,10	15,10	-	500	4.000	16.000
	3,9x19	17,60	17,60	-	500	2.000	8.000
	3,9x25	21,20	21,20	57,50	1.000	4.000	8.000
	3,9x30	25,05	25,05	-	500	2.000	8.000
	3,9x38	29,00	29,00	77,05	500	2.000	4.000
	3,9x45	33,60	33,60	-	500	2.000	4.000

* Hasta agotar existencias. * Fin serie. * End of stock.

Ref. PV-03



- | | | |
|-------------------------|--------------------|------------------------|
| • Cabeza Avellanada 90° | • Tête Fraisée 90° | • Countersunk Head 90° |
| • Rosca Plástico | • Filet Plastique | • Plastic Thread |
| • Cabeza Ø 7 mm | • Tête Ø 7mm | • Head Ø 7mm |

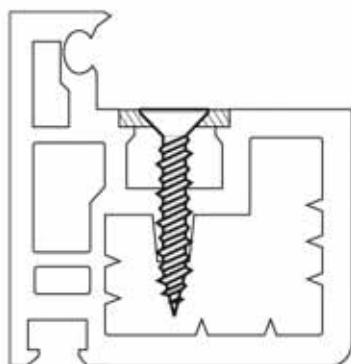

PV-00 / PV-03 / PTM-05

Diámetro Diamètre Diameter		Precios / Prix / Prices (€/1000 u.)			Envasado / Conditionnement / Packing		
		Cincado Zingué Blanc Zinc Plated	Bicromatado Bichromaté Yellow Zinc Plated	Lacado Blanco Laqué Blanc White Lacquered	Caja Retail Box	Retráctil Plastic Pack	Embalaje Pack Box
					pcs	pcs	pcs
Ø 4,3	4,3x16	16,65*	16,65*	-	500	4.000	16.000
	4,3x19	18,10*	18,10*	-	500	2.000	8.000
	4,3x22	18,90*	-	-	500	2.000	8.000
	4,3x25	21,20*	21,20*	57,30*	500	2.000	8.000
	4,3x30	22,75*	22,75*	-	500	2.000	8.000
	4,3x38	28,20*	28,20*	77,05*	500	2.000	4.000
	4,3x45	32,85*	32,85*	-	500	2.000	4.000
	4,3x55	41,25*	41,25*	-	250	1.000	2.000

* Hasta agotar existencias. * Fin serie. * End of stock.

Fijación al Perfil de PVC / Fixation de Ferrures et Gâches / Fixation on PVC Profile

Ref. PTM-05

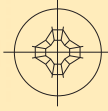

- Cabeza Gota Sebo 110°
- Tête Fraisée Bombée 110°
- Raised Countersunk Head 110°
- Rosca Plástico
- Filet Plastique
- Plastic Thread
- Recubrimiento Platinum
- Revêtement Platinum
- Platinum Coating

		Precios / Prix / Prices (€/1000 u.)	Envasado / Conditionnement / Packing		
Diámetro Diamètre Diameter		Platinum	Caja Retail Box	Retractable Plastic Pack	Embalaje Pack Box
			pcs	pcs	pcs1
Ø 4,3	4,3x16	16,65*	500	4.000	16.000
	4,3x19	18,10*	500	2.000	8.000
	4,3x22	18,90*	500	2.000	8.000
	4,3x25	21,20*	500	2.000	8.000
	4,3x30	22,25*	500	2.000	8.000
	4,3x38	28,20*	500	2.000	4.000
	4,3x45	32,85*	500	2.000	4.000
	4,3x55	41,25*	250	1.000	2.000

* Hasta agotar existencias. * Fin serie. * End of stock.

Ref. PV-15



- Cabeza Avellanada 90°
- Tête Fraisée 90°
- Countersunk Head 90°
- Tornillo de Reparación
- Vis de Réparation.
- Repair Screw.

		Precios / Prix / Prices (€/1000 u.)	Envasado / Conditionnement / Packing		
Diámetro Diamètre Diameter		Bicromatado Bichromaté Yellow Zinc Plated	Caja Retail Box	Retractable Plastic Pack	Embalaje Pack Box
			pcs	pcs	pcs
Ø 4,8	4,8x25	79,40	250	2.000	8.000
	4,8x38	99,20	250	1.000	4.000

Fijación al Perfil de PVC | Fixation de Ferrures et Gâches | Fixation on PVC Profile

Ref. PTM-16



NEW

- Cabeza Gota Sebo 110°
 - Rosca Parcial
 - Recubrimiento Platinum
 - Especial Herraje Perimetral
- Tête Fraisée Bombée 110°
 - Filet Parcial
 - Revêtement Platinum
 - Spécial Profile Périmétral
- Raised Countersunk Head 110°
 - Partial Screw
 - Platinum Coating
 - Special for Perimeter Frame

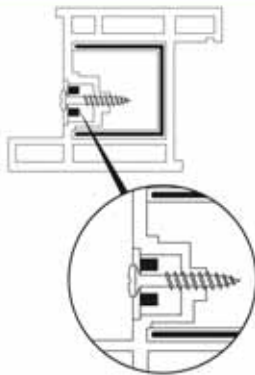

		Precios / Prix / Prices (€/1000 u.)		Envasado / Conditionnement / Packing		
Diámetro		Platinum		Caja Retail Box	Retractil Plastic Pack	Embalaje Pack Box
				pcs	pcs	pcs
Ø 4,1	4,1x25		29,50	1.000	4.000	8.000

Ref. PV-R / PV-K / PV-KO / PV-TY



- Cabeza Especial
 - Punta S Corta Plásticos
 - Philips 2
 - Fijación de Vierteaguas
- Tête Spécial
 - Pointe S Percer Plastique
 - H2
 - Fixation Rejets d'Eau
- Special Head
 - S Point Cutting Plastics
 - H2
 - Fixation of Weather Blinds

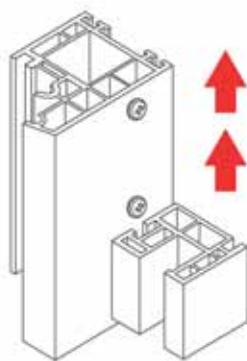

PV-R / K / KO / TY

		Precios / Prix / Prices (€/1000 u.)		Envasado / Conditionnement / Packing		
Diámetro Diamètre Diameter	Color Couleur Colour	Cincado Zingue Blanc Zinc Plated	Bicromatado Bichromaté Yellow Zinc Plated	Caja Retail Box	Retractil Plastic Pack	Embalaje Pack Box
				pcs	pcs	pcs
Ø 4,2	RH-Rehau	-	119,10	250	2.000	8.000
	VK-Veka	-	119,10	250	2.000	8.000
	KO-Kommerling	-	157,80	250	2.000	8.000
Ø 5,5	RH-Rehau	109,20	-	250	2.000	8.000
Ø 4,8	VK-Veka	112,40	-	500	2.000	8.000
Ø 5,5	KO-Kommerling	150,70	-	250	2.000	8.000
Ø 5,5	TY-Thyssen	144,15	-	250	2.000	8.000

Fijación de Montante de PVC / Fixation de Montants / Join Frames Coupling PVC Profiles

Ref. PV-70



- Cabeza Especial para Tapón Embellecedor
- Rosca Chapa

- Tête Spécial pour Adapter un Cache Vis en Plastique
- Vis à Tôle

- Special Head to Adapt Plastic Caps
- Selftapping Screw

Aplicaciones:

- Para la unión de montantes o para la fijación de marcos a la pared.

Applications:

- Fixation des Cadres au Mur.

Applications:

- Frame Fixation to the Wall..

PV-70

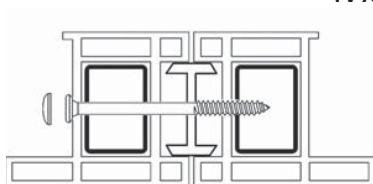

		Precios / Prix / Prices (€/1000 u.)	Envasado / Conditionnement / Packing		
Diámetro Diamètre Diameter		Bicromatado Bichromaté Yellow Zinc Plated	Caja Retail Box	Retractable Plastic Pack	Embalaje Pack Box
			pcs	pcs	pcs
Ø 4,8	4,8x55	81,90	250	1.000	2.000
	4,8x65	97,65	250	1.000	2.000
	4,8x80	115,80	100	400	800
	4,8x95	164,45	100	400	800

Ref. PV-71



- Tapón Embellecedor de Plástico para Aplicar a la Referencia PV-70 y PV-72

- Cache en Plastic pour les Vis Ref: PV-70 et PV-72

- Plastic Cap for Screw Ref: PV-70 and PV-72

		Precios / Prix / Prices (€/1000 u.)	Envasado / Conditionnement / Packing		
Color Couleur Colour	PV-71		Caja Retail Box	Retractable Plastic Pack	Embalaje Pack Box
			pcs	pcs	pcs
Blanco/Negro		26,05	1.000	4.000	8.000

Ref. PV-72

NEW



- Cabeza Especial para Tapón Embellecedor
- Tornillo Punta Broca para la Fijación Directa

- Tête Spécial pour Adapter un Cache Vis en Plastic
- Autoperceuse

- Special Head to Adapt Plastic Caps
- Selfdrilling

PV-72

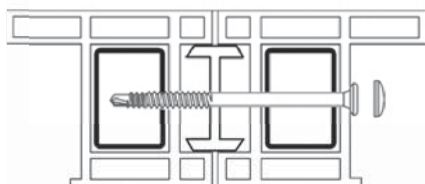

		Precios / Prix / Prices (€/1000 u.)	Envasado / Conditionnement / Packing		
Diámetro Diamètre Diameter		Cincado Zingué Blanc Zinc Plated	Caja Retail Box	Retractable Plastic Pack	Embalaje Pack Box
			pcs	pcs	pcs
Ø 4,8	4,8x70	110,00	250	1.000	2.000
	4,8x80	125,00	100	400	800
	4,8x90	180,00	100	400	800

Tornillos Punta Broca Reducida Vis Avec Pointe Autoperceuse Réduite Screws with Reduced Drilling Point

ALUDRILL

La forma más eficaz y segura para la fijación sobre aluminio,
incrementando el par de pasado de rosca.

La meilleure fixation sur aluminium, réduite le risque de foirage.

The best solution for assemblies in aluminium, reducing the risk of stripping.

- Mejor ajuste.
- Meilleur engagement.
- Better engagement.
- Menor resistencia.
- Moins resistance.
- Less resistance.

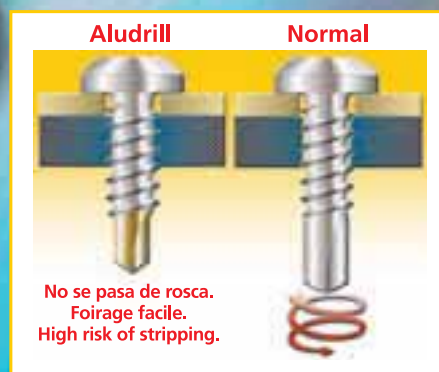

ALU - N ALU - FST ALU - H ALU - P

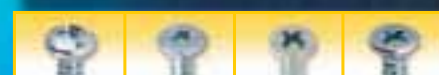

Tornillos Carpintería de Aluminio / Vis pour Profiles en Aluminum / Screws for Aluminium Profiles

Ref. ALU-N

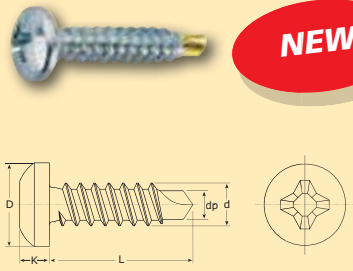

NEW

- Cabeza Alomada
- Philips (H)
- Punta Broca Reducida

- Tête Cylindrique Bombée
- Philips (H)
- Pointe Autoperceuse Réduite

- Pan Head
- Philips (H)
- Reduced Drill Point

Ø	3,9	4,2	4,8
D	7,5	8,2	9,5
K	2,8	3,05	3,55
	H2	H2	H2

Medidas en mm / Mesures en mm / Measures in mm



			Precios / Prix / Prices (€/1000 u.)	Envasado / Conditionnement / Packing		
Diámetro Diamètre Diameter			Cincado Zingué Blanc Zinc Plated	Caja Retail Box	Retractil Plastic Pack	Embalaje Pack Box
				pcs	pcs	pcs
Ø 3,9 (Nº7)	3,9 x 13	1/2	18,60	500	4.000	16.000
	3,9 x 16	5/8	19,70	500	2.000	8.000
Ø 4,2 (Nº8)	4,2 x 13	1/2	18,05	500	4.000	16.000
	4,2 x 16	5/8	19,85	500	2.000	8.000
	4,2 x 19	3/4	21,95	500	2.000	8.000
Ø 4,8 (Nº10)	4,8 x 38	1-1/2	48,15	250	1.000	2.000
	4,8 x 50	2	60,55	250	1.000	2.000
	4,8 x 63	2-1/2	81,30	250	1.000	2.000
	4,8 x 75	3	103,25	100	400	800
	4,8 x 90	3-5/8	167,75	100	400	800
	4,8 x 100	4	193,55	100	400	800

Ref. ALU-FST

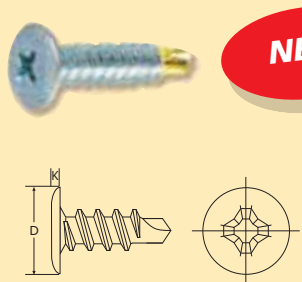

NEW

- Cabeza Baja (Forma Remache)
- Philips (H)
- Punta Broca Reducida

- Tête Plate (Type Rivet)
- Philips (H)
- Pointe Autoperceuse Réduite

- Low Head (Rivet Type)
- Philips (H)
- Reduced Drill Point

Ø	4,2
D	8,2
K	1,4
	H2

Medidas en mm / Mesures en mm / Measures in mm



			Precios / Prix / Prices (€/1000 u.)	Envasado / Conditionnement / Packing		
Diámetro Diamètre Diameter			Cincado Zingué Blanc Zinc Plated	Caja Retail Box	Retractil Plastic Pack	Embalaje Pack Box
				pcs	pcs	pcs
Ø 4,2 (Nº8)	4,2 x 13	1/2	41,35	500	4.000	16.000
	4,2 x 16	5/8	42,30	500	2.000	8.000
	4,2 x 19	3/4	49,40	500	2.000	8.000

Tornillos Carpintería de Aluminio / Vis pour Profiles en Aluminum / Screws for Aluminium Profiles

Ref. ALU-H



NEW

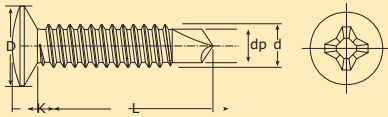

• Cabeza Gota de Sebo 120°

• Philips (H)

• Punta Broca Reducida

• Vis Fraisée Bombée 120°

• Philips (H)

• Pointe Autoperceuse Réduite

• Raised Countersunk Bored Head 120°

• Philips (H)

• Reduced Drill Point

Ø	4,2
D	7,5
K	2
	H2

Medidas en mm / Mesures en mm / Measures in mm



			Precios / Prix / Prices (€/1000 u.)	Envasado / Conditionnement / Packing		
Diámetro Diamètre Diameter			Cincado Zingué Blanc Zinc Plated	Caja Retail Box	Retractil Plastic Pack	Embalaje Pack Box
				pcs	pcs	pcs
Ø 4,2 (N°8)	4,2 x 13	1/2	17,80	500	4.000	16.000
	4,2 x 16	5/8	19,55	500	2.000	8.000
	4,2 x 19	3/4	22,60	500	2.000	8.000

Ref. ALU-P

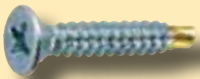

NEW

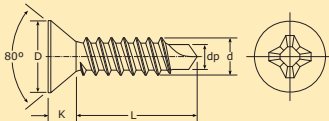

• Cabeza Avellanada

• Philips (H)

• Punta Broca Reducida

• Tête Fraisée

• Philips (H)

• Pointe Autoperceuse Réduite

• Countersunk Head

• Philips (H)

• Reduced Drill Point

Ø	3,9	4,2
D	7,5	8,2
K	2,8	3,05
	H2	H2

Medidas en mm / Mesures en mm / Measures in mm



			Precios / Prix / Prices (€/1000 u.)	Envasado / Conditionnement / Packing		
Diámetro Diamètre Diameter			Cincado Zingué Blanc Zinc Plated	Caja Retail Box	Retractil Plastic Pack	Embalaje Pack Box
				pcs	pcs	pcs
Ø 3,9 (N° 7)	3,9 x 13	1/2	17,80	500	4.000	16.000
	3,9 x 16	5/8	19,65	500	2.000	8.000
Ø 4,2 (N° 8)	4,2 x 13	1/2	17,80	500	4.000	16.000
	4,2 x 16	5/8	19,65	500	2.000	8.000
	4,2 x 19	3/4	22,60	500	2.000	8.000